



FIAT
CATÁLOGO LINHA LEVE
EDIÇÃO 15 ANO 2017

Fiat



Juntalima

Motor/Engine 1.0/1.3/1.5 8V Fiasa 146B

Códigos jogos de juntas
Code set gaskets

Modelo / Model	Cm³	De	Até	Completo com retentores 40307CR	Full set with oil seals 40307CR
Uno	994	0988	1995	Completo sem retentores 40307C	Full set without oil seals 40307C
Uno Mille	994	1994	1999	Kit retificação com retentores 40307KR	Head set with oil seals 40307KR
Prêmio	994	1988	1995	Kit retificação sem retentores 40307K	Head set without oil seals 40307K
Uno	1301	1988	1995		
Fiorino	1301	1988	1995		
Elba	1497	1988	1996		
Uno	1497	1988			

Código/Code	N° Original	Aplicação / application	MP	C	K	M
40302G	7.732.330	Cabeçote / cylinder head gasket	PAK	1	1	1
40726	46.434.617	Tampa de válvulas / rocker cover gasket	NA	1	1	1
40321	4.296.119	Coletor de escapamento / exhaust manifold	CNAC	2	2	2
40317	7.669.585	Cárter / oil pan	CB	1	1	1
40322F		Saída do escapamento / exhaust pipe	CNAC	1	1	1
40342	4.351.195	Termostato / thermostat	NA	1	1	1
40328	4.249.516	Tampa da distribuição dianteira	NA	1	1	1
40329	4.249.517	Tampa de distribuição traseira	NA	1	1	1
40349	4.477.229	Capa do óleo	NA	1	1	1
40340	4.249.520	Capa do óleo	NA	1	1	1
40332	4.250.500	Corpo da bomba de óleo	NA	1	1	1
40343	4.346.839840	Bomba de combustível / fuel pump	NA	1	1	1
40330	4.143.730	Bomba de gasolina / gasoline pump	NA	1	1	1
40346	4.346.841	Bomba de combustível / fuel pump	NA	2	2	2
40344	4.346.840	Bomba de combustível / fuel pump	NA	2	2	2
40331	4.250.780	Bomba d'água / water pump	NA	1	1	1
40341	4.193.959	Tubo da Bomba d'água / water pump	NA	1	1	1
40337	4.346.415	Bomba d'água / water pump (bocal)	NA	1	1	1
40333	4.346.834	Tampa do virabrequim	NA	1	1	1
40347	4.386.806	Tampa do virabrequim	NA	1	1	1
40339	4.296.113	Tubo do cabeçote	NA	1	1	1
40336	4.325.360	Eixo superior do comando de válvulas	NA	1	1	1
40348	4.346.836	Tubo do cabeçote	NA	1	1	1
40338	4.246.836	Tubo do cabeçote	NA	1	1	1
40335	4.206.146	Base do carburador / Base carburetor	NA	1	1	1
40345	4.109.133	Base do distribuidor	NA	1	1	1
40334	4.346.834	Tampa de óleo / oil cap	NA	1	1	1
R920008		Kit de retentores para motor completo				
R921003	755367	Retentores de haste de válvulas 8x10,8x10,3	VI	8	8	8
R924007	40000470	Retentor do comando de válvulas 30x52x7	SI	1	1	1
R923003	40004370	Retentor traseiro do virabrequim 70x85x8	SI	1	1	1
R924006	7628850	Retentor dianteiro do virabrequim 40x56x7	SI	1	1	1



JL40302G



JL40726



JL40321

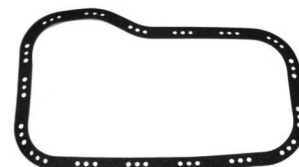

JL40317



JL40322F JL40342 JL40328



JL40329 JL40349 JL40340



JL40332 JL40343 JL40330



JL40346 JL40344 JL40331
(x2) (x2)



JL40341 JL40337 JL40333



JL40347 JL40339 JL40348



JL40335 JL40336 JL40338



JL40345 JL40334

Itens Relacionados

Gaxeta

Jogo de juntas
Carburador

Jogo de juntas
Carburador

Jogo de juntas
Câmbio

Selo do motor

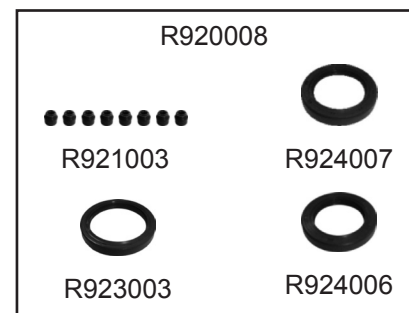

Fiat



Juntalima

Motor/Engine 1.0/1.5 8V Fiasa motor MI

Códigos jogos de juntas
Code set gaskets

Modelo / Model	Cm³	De	Até	Completo com retentores 40308CR	Full set with oil seals 40308CR
Palio	994	1996		Completo sem retentores 40308C	Full set without oil seals 40308C
Uno Mille	994	1997		Kit retificação com retentores 40308KR	Head set with oil seals 40308KR
Siena	994	1998		Kit retificação sem retentores 40308K	Head set without oil seals 40308K
Palio	1497	1996			
Fiorino	1497	1997			
Siena	1497	1998			
Strada Working	1497	1998			

Código/Code	Nº Original	Aplicação / application	MP	C	K	M
40302G	7.732.330	Cabeçote / cylinder head gasket	PAK	1	1	
40726	46.343.617	Tampa de válvulas / rocker cover gasket	NA	1	1	
40921	46.451.539	Coletor de escapamento / exhaust manifold	PAK	1	1	
40721	46.435.756	Coletor de admissão / intake manifold	NA	2	2	
40816B	50.005.585	Cárter com limitador	CB	1		
40322F		Saída do escapamento / exhaust pipe	CNAC	1	1	
40328	4.249.516	Tampa distribuição dianteira	NA	1		
40329	4.249.517	Tampa distribuição traseira	NA	1		
40728	46.426.930	Válvula termostática / thermostatic valve	NA	1	1	
40340	4.249.520	Capa de óleo	NA	1	1	
40338	4.246.836	Coletor de aspiração	NA	1	1	
40339	4.296.113	Tubo do cabeçote	NA	1		
40341	4.193.959	Tubo da Bomba d'água / water pump	NA	1		
40336	4.325.360	Eixo superior do comando de válvulas	NA	1	1	
40333	4.346.834	Tampa do virabrequim	NA	1		
40334	4.346.834	Tampa do óleo	NA	1		
40238	4.158.100	Tampa da bomba de óleo	PP	1		
40349	4.477.229	Capa de óleo	NA	1		
40347	4.386.806	Tampa do virabrequim	GV	1		
40331	4.250.780	Tampa da Bomba d'água / water pump	NA	1	1	
40332	4.250.500	Corpo da bomba de óleo	NA	1		
40448	46.440.387	Tampa traseira cabeçote	NA	1	1	
40535	4.447.229	Tampa do bloco	NA	1		
40011	46.435.757	Tampa do retentor de óleo	NA	1		
40536	4.643.610	Tampa dianteira do bloco	NA	1		
R920008		Kit de retentores para motor completo				
R921003	7553637	Retentores de haste de válvulas 8x10,8x10,3	VI	8	8	
R924007	40000470	Retentor do comando de válvulas 30x52x7	SI	1	1	
R923003	40004370	Retentor traseiro do virabrequim 70x85x8	SI	1		
R924006	7628850	Retentor dianteiro do virabrequim 40x56x7	SI	1		

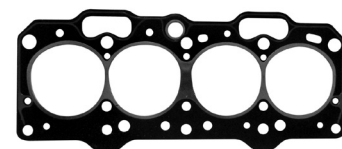

JL40302G



JL40726



JL40921



JL40721(x2)

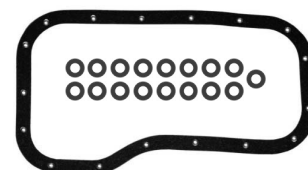

JL40816B



JL40322F



JL40328



JL40329



JL40728



JL40340



JL40338



JL40339



JL40341



JL40448



JL40336



JL40333



JL40334



JL40238



JL40349



JL40347



JL40331



JL40535



JL40536



JL40011



JL40332

Itens Relacionados

Gaxeta

Juntas para Injeção Eletrônica

Juntas para Câmbio

Juntas para Câmbio

Selo do motor

JL40763
Gaxeta do escapamento
Fiat (todos)

JL15707
Jogo de juntas I.E.
Palio 1.0/1.5 MPI 8V

JL40390
Jg junta câmbio
Fiat moderno 4 marchas

JL40391
Jogo junta do câmbio
Fiat todos 5 marchas

JL40830
Selo do motor
Fiat Uno/ Palio/ Ideia
1.0/ 1.3/ 1.4 8V

R920008

R921003

R924007

R923003

R924006

Fiat



Juntalima

Motor/Engine 1.0 8V Fire 1714020

Códigos jogos de juntas
Code set gaskets

Modelo / Model	Cm ³	De	Até	Completo com retentores 40801CR	Full set with oil seals 40801CR
Palio	999	2000		Completo sem retentores 40801C	Full set without oil seals 40801C
Siena Fire	999	2002		Completo MLS com retentores 40801CMR	Full set MLS with oil seals 40801CMR
Uno Mille Fire	999			Completo MLS sem retentores 40801CM	Full set MLS without oil seals 40801CM
				Kit retificação com retentores 40801KR	Head set with oil seals 40801KR
				Kit retificação sem retentores 40801K	Head set without oil seals 40801K
				Kit retificação MLS com retentores 40801KMR	MLS Head set with oil seals 40801KMR
				Kit retificação MLS sem retentores 40801KM	MLS Head set without oil seals 40801KM

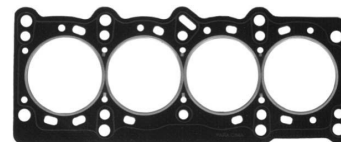

JL40803AG



JL40803MLS

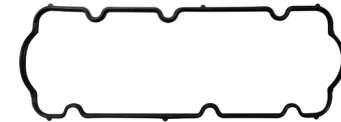

JL40826



JL40021

JL40022



JL10123



JL40024

Código/Code	N° Original	Aplicação / application	MP	C	K	M
40803AG	46.546.120	Cabeçote / cylinder head gasket	PAK	1	1	
40803MLS	46.546.120	Cabeçote / cylinder head gasket	MLS			1
40826	46.748.519	Tampa de válvulas / rocker cover gasket	BO	1	1	1
40021	46.404.428	Coletor de escapamento / exhaust manifold	CNAC	2	2	2
40022	70.824.99	Coletor de admissão / intake manifold	SI	4	4	4
10123	70.844.34	Coletor de admissão / intake manifold	SI	1	1	1
40024		Conexão do sensor de temperatura	SI	1	1	1
40116BO		Cárter / oil pan	BO	1		1
40622	46.465.291	Saída do escapamento / exhaust pipe	CNAC	1	1	1
40138	46.552.427	Bomba de óleo / oil pump	NA	1	1	1
40646	7.604.488	Válvula termostática / thermostatic valve	NA	1	1	1
46688		Borracha 56x51	BO	1		1
JLKB049		Kit de borrachas / kit rubbers	KB	1		1
R920001		Kit de retentores para motor completo				
R921001	7581344	Retentores de haste de válvulas 7x9,8x10	VI	8	8	8
R924002	40004240	Retentor do comando de válvulas 30x42x7	SI	1	1	1
R922001	46788297	Retentor traseiro do virabrequim com flange	SI	1		1
R924001	46404094	Retentor dianteiro do virabrequim 27x37x7	SI	1		1

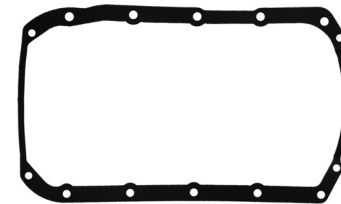

JL40116BO



JL40622



JL40138



JL40646



JL46688

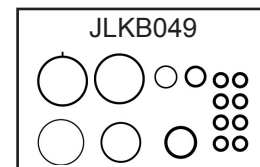

JLKB049

Itens Relacionados

Selo do motor



JL40830
Selo do motor
Fiat Uno/ Palio/ Ideia
1.0/ 1.3/ 1.4 8V

Em breve novidades

Em breve novidades

Em breve novidades

Em breve novidades

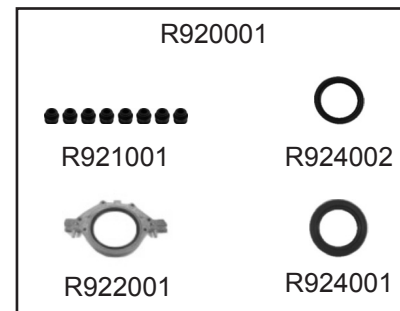

R920001

R921001

R924002



R922001



R924001

Fiat



Juntalima

Motor/Engine 1.0/1.3 16V Fire 188A5.0000

Códigos jogos de juntas
Code set gaskets

Modelo / Model	Cm³	De	Até	Completo com retentores 40802CR	Full set with oil seals 40802CR
Palio (DOHC)	999	2000		Completo sem retentores 40802C	Full set without oil seals 40802C
Palio	1242	2001		Completo MLS com retentores 40802CMR	Full set MLS with oil seals 40802CMR
Siena	1242	2000		Completo MLS sem retentores 40802CM	Full set MLS without oil seals 40802CM
Dobló EX Fire	1242	2001		Kit retificação com retentores 40802KR	Head set with oil seals 40802KR
Palio Flex	1242	2001		Kit retificação sem retentores 40802K	Head set without oil seals 40802K
				Kit retificação MLS com retentores 40802KMR	MLS Head set with oil seals 40802KMR
				Kit retificação MLS sem retentores 40802KM	MLS Head set without oil seals 40802KM

Código/Code	N° Original	Aplicação / application	MP	C	K	M
40804AG	46.541.740	Cabeçote / cylinder head gasket	PAK	1	1	
40804MLS	46.541.740	Cabeçote / cylinder head gasket	MLS			1
40426	46.513.955	Tampa de válvulas / rocker cover gasket	MLS	1	1	1
40121	46.526.271	Coletor de escapamento / exhaust manifold	PAK	1	1	1
40023	71.716.583/4	Jogo do coletor de admissão / kit for intake manifold	SI	1	1	1
40916		Cárter / oil pan	CB	1	1	1
40523	46+.774.747	Saída do escapamento / exhaust pipe	CNAC	1	1	1
40545	46.751.961	Tampa da distribuição / timing cover	NA	1		1
40139	46.552.317	Bomba de óleo / oil pump	NA	1	1	1
40646	7.604.488	Válvula termostática / thermostatic valve	NA	1	1	1
JL46688	7689903	Corpo da borboleta ao bloco	BO	1		1
JLKB048		Kit de borrachas / kit rubbers	KB	1		1
R920002		Kit de retentores para motor completo				
R911002	7581344	Retentores de haste de válvulas 6x8,8x12	VI	16	16	16
R924003	40004240	Retentor do comando de válvulas 40x55x7	SI	2	2	2
R922002	46788297	Retentor traseiro do virabrequim com flange	SI	1		1
R924001		Retentor dianteiro do virabrequim 27x37x7	SI	1		1

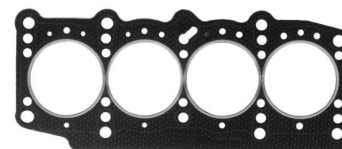

JL40804AG

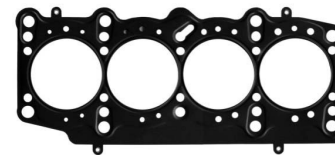

JL40804MLS

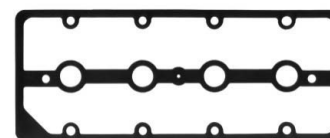

JL40426



JL40121

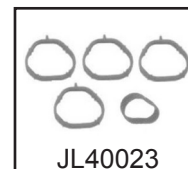

JL40023



JL40916



JL40523



JL40545



JL40139



JL40646



JL46688

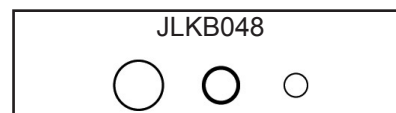

JLKB048

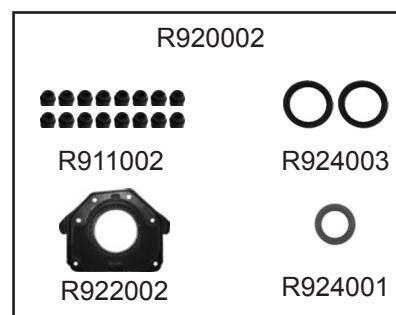

R920002



R911002



R924003



R922002



R924001

Itens Relacionados

Selo do motor



Em breve novidades

Em breve novidades

Em breve novidades

Em breve novidades



Motor/Engine 1.0 / 1.3 8V Fiasa (147)

Códigos jogos de juntas
Code set gaskets

Modelo / Model	Cm ³	De	Até	Completo com retentores 40306CR	Full set with oil seals 40306CR
147	1049	1977	1988	Completo sem retentores 40306C	Full set without oil seals 40306C
Oggi	1049	1977	1988	Kit retificação com retentores 40306KR	Head set with oil seals 40306KR
Fiorino	1049	1977	1988	Kit retificação sem retentores 40306K	Head set without oil seals 40306K
Uno	1049	1977	1988		
Prêmio	1049	1980	1988		
Elba	1049	1980	1988		
Uno/Fiorino	1301	1977	1988		
Prêmio	1301	1980	1988		
Elba	1301	1980	1988		

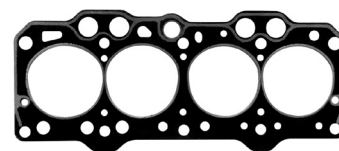

JL40301AG



JL40326



JL40321

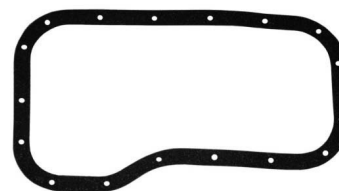

JL40316

Código/Code	N° Original	Aplicação / application	MP	C	K	M
40301AG	4.387.346	Cabeçote / cylinder head gasket	PAK	1	1	1
40326	4.323.710	Tampa de válvulas / rocker cover gasket	CB	1	1	1
40321	4.296.119	Coletor de escapamento / exhaust manifold	CNAC	1	1	1
40316	4.249.510	Cárter / oil pan	CB	1	1	1
40322F		Saída do escapamento / exhaust pipe	CNAC	1	1	1
40328	4.249.516	Tampa da distribuição dianteira	NA	1	1	1
40329	4.249.517	Tampa da distribuição traseira	NA	1	1	1
40349	4.386.808	Capa de óleo	NA	1	1	1
40340	4.249.520	Capa de óleo	NA	1	1	1
40332	4.250.500	Corpo da bomba de óleo	NA	1	1	1
40343	4.346.839540	Bomba de combustível / fuel pump	NA	1	1	1
40330	4.143.730	Bomba de gasolina / gasoline pump	NA	1	1	1
40346	4.346.841	Bomba de combustível / fuel pump	NA	2	1	1
40344	4.346.840	Bomba de combustível / fuel pump	NA	2	1	1
40331	4.250.780	Bomba d'água / water pump	NA	1	1	1
40341	4.193.959	Tubo da Bomba d'água / water pump	NA	1	1	1
40337	4.346.415	Bomba d'água / water pump (bocal)	NA	1	1	1
40333	4.346.834	Tampa do virabrequim	NA	1	1	1
40347	4.386.806	Tampa do virabrequim	NA	1	1	1
40339	4.296.113	Tubo do cabeçote	NA	1	1	1
40336	4.325.360	Eixo superior do comando de válvulas	NA	1	1	1
40348	4.346.836	Coletor de aspiração	NA	1	1	1
40338	4.246.836	Coletor de aspiração	NA	1	1	1
40335	4.206.146	Base do carburador / Base carburetor	NA	1	1	1
40342	4.351.195	Termostato / thermostat	NA	1	1	1
40334		Tampa do óleo	NA	1	1	1
40345	4.109.133	Base do distribuidor	NA	1	1	1
R920008		Kit de retentores para motor completo (após 1984)				
R921003	7553637	Retentores de haste de válvulas 8x10,8x10,3	VI	16	16	
R924007	40000470	Retentor do comando de válvulas 30x52x7	SI	1	1	
R923003	40004370	Retentor traseiro do virabrequim 70x85x8 (após 1984)	SI	1	1	
R924006	7628850	Retentor dianteiro do virabrequim 40x56x7	SI	1	1	



JL40322F JL40328 JL40329



JL40349 JL40340 JL40332



JL40343 JL40330 JL40346(x2)



JL40344(x2) JL40331 JL40341



JL40337 JL40333 JL40347



JL40334 JL40339 JL40336 JL40348



JL40338 JL40335 JL40342 JL40345

Itens Relacionados

Retentores

Gaxeta

Jogo de juntas para carburador

Jogo de juntas para carburador

Jogo de juntas para câmbio



JL923002

Retentor traseiro do virabrequim até 1984 64x80x8 - 40000460



JL40763

Gaxeta escapamento Fiat (todos)



JL40350

Jg juntas carburador Fiat 147-1300 Solex Emb 1 jogo



JL40360

Jg juntas carburador Fiat 1050-1300 Weber duplo

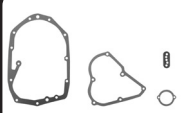

JL40380

Jogo juntas câmbio Fiat 147 todos

R920008

R921003

R924007

R923003

R924006

Fiat



Juntalima

Motor/Engine 1.3 8V 188A4.000 Fire

Códigos jogos de juntas
Code set gaskets

Modelo / Model	Cm³	De	Até	Completo com retentores 40905CR	Full set with oil seals 40905CR
Strada	1242	2002		Completo sem retentores 40905C	Full set without oil seals 40905C
Palio	1242	2002		Completo MLS com retentores 40905CMR	Full set MLS with oil seals 40905CMR
Siena	1242	2002		Completo MLS sem retentores 40905CM	Full set MLS without oil seals 40905CM
Fiorino Furgão	1242	2002		Kit retificação com retentores 40905KR	Head set with oil seals 40905KR
Uno Furgão	1242	2002		Kit retificação sem retentores 40905K	Head set without oil seals 40905K
Strada Fire	1242	2002		Kit retificação MLS com retentores 40905KMR	MLS Head set with oil seals 40905KMR
				Kit retificação MLS sem retentores 40905KM	MLS Head set without oil seals 40905KM



JL40803AG



JL40803MLS

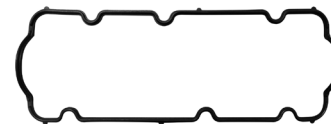

JL40826



JL40021

JL40722

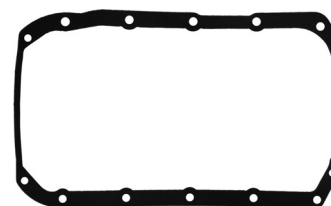

JL40116BO



JL40622



JL40138



JL46688



JL40646



JL40024



JL40232

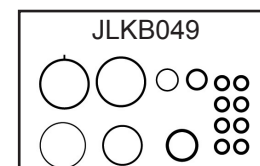

JLKB049

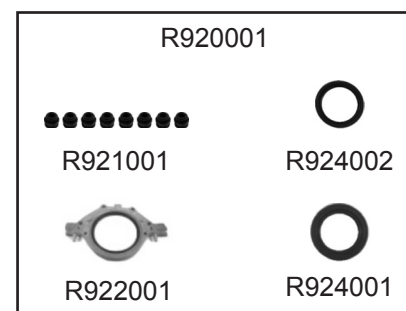

R920001

R921001

R924002

R922001

R924001

Código/Code	Nº Original	Aplicação / application	MP	C	K	M
40803AG	46.546.120	Cabeçote / cylinder head gasket	PAK	1	1	
40803MLS	46.546.120	Cabeçote / cylinder head gasket	MLS			1
40826	46.748.519	Tampa de válvulas / rocker cover gasket	BO	1	1	1
40021	46.404.428	Coletor de escapamento / exhaust manifold	CNAC	2	2	2
40722	70.824.99	Coletor de admissão / intake manifold	SI	4	4	4
40116BO		Cárter / oil pan	BO	1		1
40622	46.465.291	Saída do escapamento / exhaust pipe	CNAC	1	1	1
40138	46.552.427	Bomba de óleo / oil pump	NA	1	1	1
40646	7.604.488	Válvula termostática / thermostatic valve	NA	1	1	1
40024		Conexão sensor de temperatura	SI	1	1	1
40232		Bomba d'água / water pump	GV	1		1
46688		Borracha 56x51	BO	1		1
JLKB049		Kit de borrachas / kit rubbers	KB	1		1
R920001		Kit de retentores para motor completo	NA			
R921001	7581344	Retentores de haste de válvulas 7x10,8x10	VI	8	8	8
R924002	40004240	Retentor do comando de válvulas 30x42x7	SI	1	1	1
R922001	46788297	Retentor traseiro do virabrequim com flange	VI	1		1
R924001	46404094	Retentor dianteiro do virabrequim 27x37x7	SI	1		1

Itens Relacionados

Selo do motor



Em breve novidades

Em breve novidades

Em breve novidades

Em breve novidades

Fiat



Juntalima

Motor/Engine 1.4 8V Fire

Códigos jogos de juntas
Code set gaskets

Modelo / Model	Cm³	De	Até	Completo com retentores 40803CR	Full set with oil seals 40803CR
Palio	1368	2005		Completo sem retentores 40803C	Full set without oil seals 40803C
Siena	1368	2005		Completo MLS com retentores 40803CMR	Full set MLS with oil seals 40803CMR
Punto	1368	2005		Completo MLS sem retentores 40803CM	Full set MLS without oil seals 40803CM
Uno	1368	2005		Kit retificação com retentores 40803KR	Head set with oil seals 40803KR
				Kit retificação sem retentores 40803K	Head set without oil seals 40803K
				Kit retificação MLS com retentores 40803KMR	MLS Head set with oil seals 40803KMR
				Kit retificação MLS sem retentores 40803KM	MLS Head set without oil seals 40803KM



JL40804G



JL40805MLS



JL40826



JL40021



JL40022

JL40024

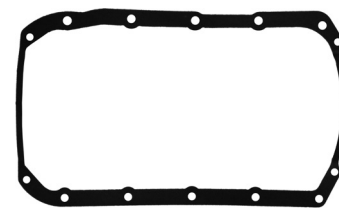

JL40116BO



JL40622



JL40139



JL02507



JL40646

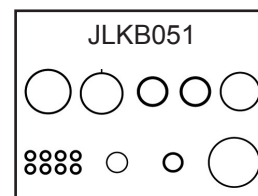

JLKB051

Código/Code	N° Original	Aplicação / application	MP	C	K	M
40804		Cabeçote / cylinder head gasket	PAK	1	1	
40805MLS	55190882	Cabeçote / cylinder head gasket	MLS			1
40826	46.748.519	Tampa de válvulas / rocker cover gasket	BO	1	1	1
40021	46.404.428	Coletor de escapamento / exhaust manifold	CNAC	2	2	2
40022	70.824.99	Coletor de admissão / intake manifold	SI	4	4	4
40024		Conexão do sensor de temperatura	SI	1	1	1
40116BO		Cárter / oil pan	BO	1		1
40622	46.465.291	Saída do escapamento / exhaust pipe	CNAC	1	1	1
40139	46.552.317	Bomba de óleo / oil pump	NA	1	1	1
02507		Borracha 30x4	BO	1		1
40646	7.604.488	Válvula termostática / thermostatic valve	NA	1	1	1
JLKB051		Kit de borrachas / kit rubbers	KB	1	1	1
R920003		Kit de retentores para motor completo				
R921004	46470334	Retentores de haste de válvulas 4x7,5x8	VI	8	8	8
R924002	46404094	Retentor do comando de válvulas 30x42x7	SI	1		1
R922002	46788297	Retentor traseiro do virabrequim com flange	SI	1		1
R924001	40004240	Retentor dianteiro do virabrequim 27x37x7	SI	1	1	1

Itens Relacionados

Selo do motor



JL40830
Selo do motor
Fiat Uno/ Palio/ Ideia
1.0/ 1.3/ 1.4 8V

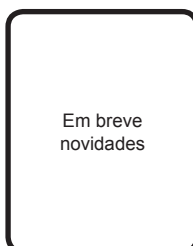

Em breve novidades

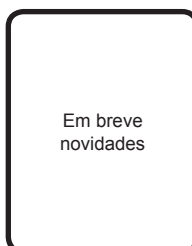

Em breve novidades

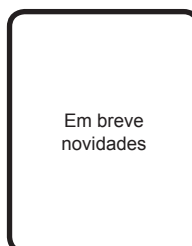

Em breve novidades

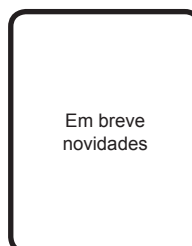

Em breve novidades

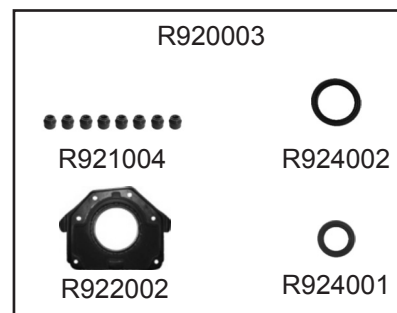

R920003

R921004



R924002



R922002



R924001

Fiat



Juntalima

Motor/Engine 1.4 8V Fire

Códigos jogos de juntas
Code set gaskets

Modelo / Model	Cm³	De	Até	Completo com retentores 40903CR	Full set with oil seals 40903CR
Palio	1368	2005		Completo sem retentores 40903C	Full set without oil seals 40903C
Siena	1368	2005		Completo MLS com retentores 40903CMR	Full set MLS with oil seals 40903CMR
Punto	1368	2005		Completo MLS sem retentores 40903CM	Full set MLS without oil seals 40903CM
Uno	1368	2005		Kit retificação com retentores 40903KR	Head set with oil seals 40903KR
				Kit retificação sem retentores 40903K	Head set without oil seals 40903K
				Kit retificação MLS com retentores 40903KMR	MLS Head set with oil seals 40903KMR
				Kit retificação MLS sem retentores 40903KM	MLS Head set without oil seals 40903KM

Código/Code	Nº Original	Aplicação / application	MP	C	K	M
40804G	55190882	Cabeçote / cylinder head gasket	PAK	1		
40805MLS	55190882	Cabeçote / cylinder head gasket	MLS			1
40826	46.748.519	Tampa de válvulas / rocker cover gasket	BO	1	1	1
40021	46.404.428	Coletor de escapamento / exhaust manifold	CNAC	1	1	1
40722	70.824.99	Coletor de admissão / Intake manifold	SI	4	4	4
40024		Conexão do sensor de temperatura	SI	1	1	1
40916		Cárter / oil pan	CB	1		1
40622	46.465.291	Saída do escapamento / exhaust pipe	CNAC	1	1	1
40139	46.552.317	Bomba de óleo / oil pump	NA	1	1	1
40646	7.604.488	Válvula termostática / thermostatic valve	NA	1	1	1
40545	46.751.961	Tampa da distribuição / timing cover	NA	1		1
40232		Bomba d'água / water pump	GV	1		1
02507		Anel de borracha 30X4	BO	1		1
JLKB051		Kit de borrachas / kit rubbers	KB	1	1	1
R920003		Kit de retentores para motor completo				
R921004	46470334	Retentores de haste de válvulas 4x7,5x8	VI	8	8	8
R924002	40004240	Retentor do comando de válvulas 30x47x7	SI	1	1	1
R922002	46788297	Retentor traseiro do virabrequim com flange	SI	1		1
R924001	46404094	Retentor dianteiro do virabrequim 27x37x7	SI	1		1



JL40804G

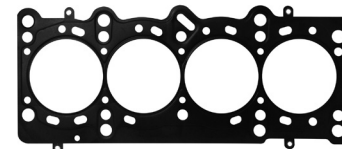

JL40805MLS



JL40826



JL40021

JL40722



JL40024



JL40916



JL40622



JL40139



JL40646



JL40545



JL40232



JL02507

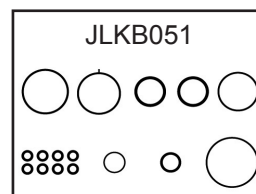

JLKB051

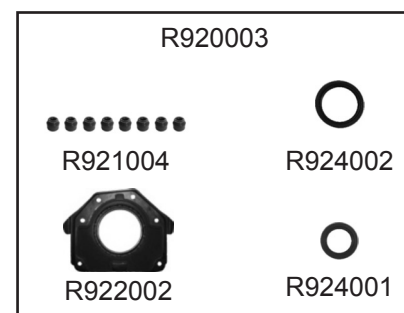

R920003

R921004

R924002



R922002



R924001

Itens Relacionados

Selo do motor



JL40830
Selo do motor
Fiat Uno/ Palio/ Ideia
1.0/ 1.3/ 1.4 8V

Em breve novidades

Em breve novidades

Em breve novidades

Em breve novidades



Motor/Engine 1.0/1.4 8V Fire Evo

Códigos jogos de juntas
Code set gaskets

Modelo / Model	Cm³	De	Até	Completo com retentores 40102CR	Full set with oil seals 40102CR
Palio	999	2009		Completo sem retentores 40102C	Full set without oil seals 40102C
Uno	999	2009		Completo MLS com retentores 40102CMR	Full set MLS with oil seals 40102CMR
Grand Siena	1368	2009		Completo MLS sem retentores 40102CM	Full set MLS without oil seals 40102CM
Punto	1368	2009		Kit retificação com retentores 40102KR	Head set with oil seals 40102KR
Idea	1368	2009		Kit retificação sem retentores 40102K	Head set without oil seals 40102K
500	1368	2009		Kit retificação MLS com retentores 40102KMR	MLS Head set with oil seals 40102KMR
Palio	1368	2009		Kit retificação MLS sem retentores 40102KM	MLS Head set without oil seals 40102KM
Uno	1368	2009			



JL40804G



JL40805MLS

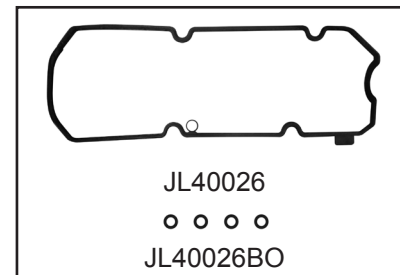

JL40026

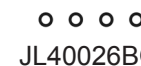

JL40026BO

JL40026K



JL40021

JL40124



JL40024



JL40916



JL40139



JL40138



JL40646



JL40545



JL40232



JL02507

JLKB050

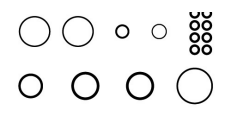

Código/Code	N° Original	Aplicação / application	MP	C	K	M
40804G		Cabeçote / cylinder head gasket	PAK	1		
40805MLS		Cabeçote / cylinder head gasket	MLS			1
40026		Tampa de válvulas / rocker cover gasket	BO	1	1	1
40026BO		Aneis de vedação	BO	4	4	4
40026K		Kit tampa de válvulas / rocker cover set	BO			
40021		Coletor de escapamento / exhaust manifold	CNAC	1	1	1
40124		Coletor de admissão / intake manifold	SI	4	4	4
40024		Conexão do sensor de temperatura	SI	1	1	1
40916		Cárter / oil pan	CB	1		1
40139	46.552.317	Bomba de óleo / oil pump	NA	1	1	1
40138	46.552.427	Bomba de óleo / oil pump	NA	1	1	1
40646	7.604.488	Válvula termostática / thermostatic valve	NA	1	1	1
40545	46.751.961	Tampa da distribuição / timing cover	NA	1	1	1
40232		Bomba d'água / water pump	GV	1	1	1
02507		Anel de borracha 30x4	BO	1		1
JLKB050		Kit de borrachas / kit rubbers	KB	1		1
R920004		Kit de retentores para motor completo				
R921004	46470334	Retentores de haste de válvulas 4x7,5x8	VI	8	8	8
R924011	40004240	Retentor do comando de válvulas 31x55x7	SI	1	1	1
R922001	46788297	Retentor traseiro do virabrequim com flange	SI	1		1
R924001	46404094	Retentor dianteiro do virabrequim 27x37x7	SI	1		1

Itens Relacionados

Selo do motor



JL40830
Selo do motor
Fiat Uno/ Palio/ Idea
1.0/ 1.3/ 1.4 8V

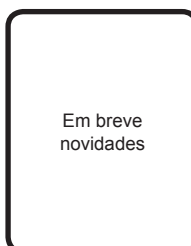

Em breve novidades

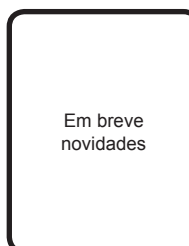

Em breve novidades

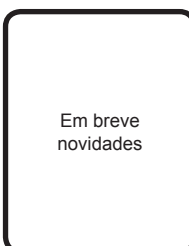

Em breve novidades

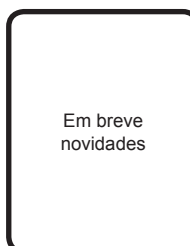

Em breve novidades

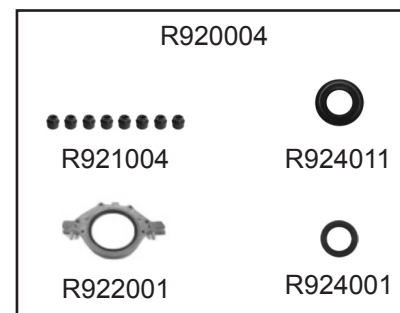

R920004



R921004



R924011



R922001



R924001

Fiat



Juntalima

Motor/Engine 1.5 8V Sevel Fiat 138C3
(Argentino)

Códigos jogos de juntas
Code set gaskets

Modelo / Model Cm³ De Até

Prêmio	1498	1985	
Uno	1498	1985	
Elba	1498	1985	
Tipo	1498	1985	

Completo com retentores
40506CR
Completo sem retentores
40506C
Kit retificação com retentores
40506KR
Kit retificação sem retentores
40506K

Full set with oil seals
40506CR
Full set without oil seals
40506C
Head set with oil seals
40506KR
Head set without oil seals
40506K

Código/Code	Nº Original	Aplicação / application	MP	C	K	M
40501AG	7.508.621	Cabeçote / cylinder head gasket	PAK	1	1	
40525	4.474.289	Cabeçote superior	NA	1	1	
40526	4.300.225	Tampa de válvulas / rocker cover gasket	CB	1	1	
40521	4.309.031	Coletor de escapamento / exhaust manifold	PAK	2	2	
40516	4.179.038	Cárter / oil pan	CB	1		
40322F		Saída do escapamento / exhaust pipe	CNAC	1	1	
40528	4.179.043	Tampa árvore de manivelas	NA	1		
40529	4.302.267	Tampa árvore manivelas traseira	NA	1		
40530	4.179.154	Bomba d'água / water pump	GV	1	1	
40546	4.179.155	Corpo da Bomba d'água / water pump	NA	1		
40341	4.198.159	Válvula termostática / thermostatic valve	NA	1		
40527	4.179.117	Suporte do comando de válvulas	NA	1	1	
40351	4.176.154	Flange da entrada da Bomba d'água	NA	1		
40238	4.158.100	Bomba de óleo / oil pump	NA	1		
40538	4.179.138	Tampa da bomba de óleo	GV	1		
40544	5.937.811	Tensor da correia dentada	GV	1		
40514	4.254.031	Tampa do bloco do motor	NA	1		
40515	4.254.019	Tampa insp. do mancal	NA	1	1	
40537	4.158.100	Base do distribuidor	NA	1		
40345	4.109.133	Base do distribuidor	NA	2		
40547	4.198.159	Válvula termostática / thermostatic valve	NA	1		
40332		Corpo da bomba de óleo	NA	1		
R920007		Kit de retentores para motor completo				
R921003	7553637	Retentores de haste de válvulas 8x10,8x10,3	VI	8	8	
R924007	40000470	Retentor do comando de válvulas 30x52x7	SI	1	1	
R923002	40000460	Retentor traseiro do virabrequim 64x80x8	SI	1		
R924006	7628850	Retentor dianteiro do virabrequim 40x56x7	SI	1		



JL40501AG



JL40525



JL40526



JL40521

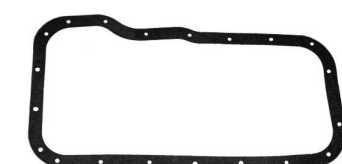

JL40516



JL40322F

JL40528

JL40529



JL40530

JL40546

JL40341



JL40527

JL40351

JL40238



JL40538

JL40544

JL40514



JL40515

JL40537

JL40345(x2)



JL40547

JL40332

Itens Relacionados

Gaxeta

Juntas para Câmbio

Juntas para Câmbio

JL40763
Gaxeta do escapamento Fiat (todos)

JL40390
Jg junta câmbio Fiat moderno 4 marchas

JL40391
Jogo junta do câmbio Fiat todos 5 marchas

Em breve novidades

Em breve novidades

R920007

R921003 R924007
R923002 R924006

Fiat



Juntalima

Motor/Engine 1.6 8V Argentino

Códigos jogos de juntas
Code set gaskets

Modelo / Model	Cm³	De	Até
Uno	1591	1989	
Prêmio	1591	1989	
Elba	1591	1989	

Completo com retentores
40606CR
Completo sem retentores
40606C
Kit retificação com retentores
40606KR
Kit retificação sem retentores
40606K

Full set with oil seals
40606CR
Full set without oil seals
40606C
Head set with oil seals
40606KR
Head set without oil seals
40606K



JL40601AG

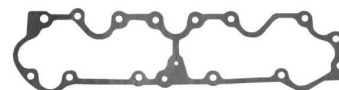

JL40625



JL40626



JL40621

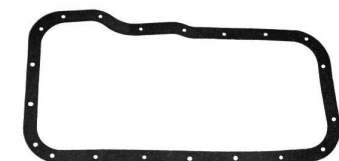

JL40516



JL40322AF

JL40528



JL40529

JL40530

JL40546



JL40544

JL40515

JL40538



JL40330

JL40343

JL40344



JL40346

JL40527

JL40645



JL40547

JL40348

JL40341



JL40537



JL40345

Código/Code	N° Original	Aplicação / application	MP	C	K	M
40601AG	7.667.005	Cabeçote / cylinder head gasket	PAK	1	1	
40625	4.474.289	Cabeçote superior	NA	1	1	
40626	7.554.851	Tampa de válvulas / rocker cover gasket	CB	1	1	
40621	7.625.373	Coletor de escapamento / exhaust manifold	PAK	2	2	
40516	4.179.038	Cárter / oil pan	CB	1		
40322AF		Saída do escapamento / exhaust pipe	CNAC	1	1	
40528	4.179.043	Tampa árvore de manivelas	NA	1		
40529	4.302.267	Tampa árvore de manivelas traseira	NA	1		
40530	4.179.154	Bomba d'água / water pump	GV	1	1	
40546	4.179.155	Corpo da Bomba d'água / water pump	NA	1		
40544	5.937.811	Tensor da correia dentada	GV	1		
40515	4.195.119	Tampa de óleo / oil cap	NA	1	1	
40538	4.179.138	Tampa da bomba de óleo	GV	1		
40330	4.143.730	Tampa do virabrequim	NA	1		
40343	4.346.839840	Bomba de combustível / fuel pump	NA	1		
40344	4.346.840	Bomba de combustível / fuel pump	NA	1		
40346	4.346.841	Bomba de combustível / fuel pump	NA	1		
40527	4.179.117	Suporte do comando de válvulas	NA	1	1	
40645	7.615.049	Válvula termostática / thermostatic valve	NA	1	1	
40547	4.198.159	Válvula termostática / thermostatic valve	NA	1		
40348	4.346.836	Coletor de aspiração	NA	1		
40341	4.193.959	Tubo da Bomba d'água / water pump	NA	1		
40537	4.158.100	Base do distribuidor	NA	1		
40345	4.109.133	Base do distribuidor	NA	1		
R920007		Kit de retentores para motor completo				
R921003	7553637	Retentores de haste de válvulas 8x10,8x10,3	VI	8	8	
R924007	40000470	Retentor do comando de válvulas 30x52x7	SI	1	1	
R923002	40000460	Retentor traseiro do virabrequim 64x80x8	SI	1		
R924006	7628850	Retentor dianteiro do virabrequim 40x56x7	SI	1		

Itens Relacionados

Gaxeta

Juntas para Câmbio

Juntas para Câmbio



JL40763
Gaxeta do escapamento Fiat (todos)



JL40390
Jg junta câmbio Fiat moderno 4 marchas

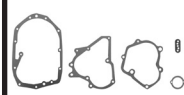

JL40391
Jogo junta do câmbio Fiat todos 5 marchas

Em breve novidades

Em breve novidades

R920007



R921003



R924007



R923002



R924006

Fiat



Juntalima

Motor/Engine 1.6 8V 160E2.01L

Códigos jogos de juntas
Code set gaskets

Modelo / Model	Cm³	De	Até	Completo com retentores 40607CR	Full set with oil seals 40607CR
Tipo I.E.	1581	1993	1995	Completo sem retentores 40607C	Full set without oil seals 40607C
Tempra I.E.	1581	1993	1997	Kit retificação com retentores 40607KR Kit retificação sem retentores 40607K	Head set with oil seals 40607KR Head set without oil seals 40607K

Código/Code	Nº Original	Aplicação / application	MP	C	K	M
40601AG	7.564.332	Cabeçote / cylinder head gasket	PAK	1	1	
40227	7.554.851	Tampa de válvulas / rocker cover gasket	CB	1	1	
40725	7.784.728	Regulagem das válvulas	NA	1	1	
40223	7.772.495	Coletor de admissão / intake manifold	PAK	1	1	
40217	5.000.291	Cárter / oil pan	CB	1		
40528	4.179.043	Tampa da árvore de manivela	NA	1		
40529	4.302.267	Tampa árvore de manivela traseira	NA	1		
40544	5.937.811	Tensor da correia dentada	NA	1		
40530	7.770.026	Bomba d'água / water pump	GV	1	1	
40515	4.195.119	Tampa de óleo / oil cap	NA	1	1	
40538	4.179.138	Tampa da bomba de óleo do motor	NA	1	1	
40527	4.179.177	Suporte do comando de válvulas	NA	1	1	
40541	7.597.760	Tampa comando de válvulas	NA	1	1	
40546	4.179.155	Guarnição	NA	1		
FT014	4.193.959	Suporte da Bomba d'água / water pump	NA	1		
40542	46.584.559	Válvula do termostato	NA	1		
10936	4.158.100	Distribuição ignição	NA	1		
R920007		Kit de retentores para motor completo				
R921003	7553637	Retentores de haste de válvulas 8x10,8x10,3	VI	8	8	
R924007	40000470	Retentor do comando de válvulas 30x52x7	SI	1	1	
R923002	40000460	Retentor traseiro do virabrequim 64x80x8	SI	1		
R924006	7628850	Retentor dianteiro do virabrequim 40x56x7	SI	1		



JL40601AG



JL40227



JL40725



JL40223

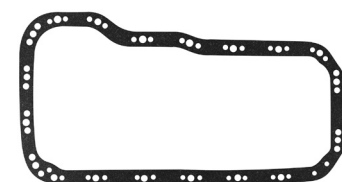

JL40217



JL40528

JL40529



JL40530

JL40544



JL40515

JL40538



JL40527

JL40541

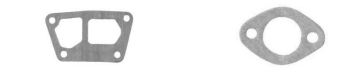

JL40546

FT014



JL40542

JL10936

Itens Relacionados

Gaxeta

Jogo de juntas para injeção eletrônica

Jogo de juntas para injeção eletrônica

Jogo de juntas para câmbio

Jogo de juntas para câmbio

JL40763
Gaxeta do escapamento Fiat (todos)

JL15709
Jogo de juntas I.E. Tipo 1.6 nacional Multipoint

JL15701
Jogo de juntas I.E. Tipo 1.6 nacional Multipoint

JL40390
Jogo juntas câmbio Fiat moderno 4 marchas

JL40391
Jogo juntas câmbio Fiat todos 5 marchas

R920007
R921003
R924007
R923002
R924006

Fiat



Juntalima

Motor/Engine 1.6 16V 178B/ 182A4

Códigos jogos de juntas
Code set gaskets

Modelo / Model	Cm³	De	Até	Completo com retentores 40406CR	Full set with oil seals 40406CR
Palio	1581	1996		Completo sem retentores 40406C	Full set without oil seals 40406C
Siena	1581	1997		Kit retificação com retentores 40406KR	Head set with oil seals 40406KR
Brava	1581	1999		Kit retificação sem retentores 40406K	Head set without oil seals 40406K
Marea	1581	1999			

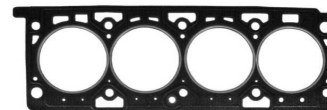

JL40401G



JL40229(x2)



JL40421



JL40422

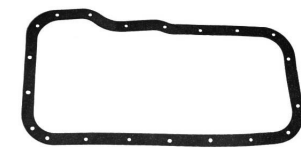

JL40516



JL40523



JL40528



JL40529



JL40515



JL40538



JL40539



JL40540



JL40541



JL40542



JL40543



JL40888B

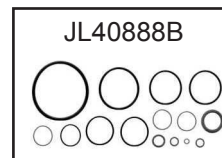

Código/Code	N° Original	Aplicação / application	MP	C	K	M
40401G	46.410.960	Cabeçote / cylinder head gasket	PAK	1	1	
40229	4.773.831	Regulagem das válvulas	NA	2	2	
40421	46.412.116	Coletor de escapamento / exhaust manifold	PAK	1	1	
40422	46.410.505	Coletor de admissão / intake manifold	PAK	1	1	
40516	4.179.038	Cárter / oil pan	CB	1		
40523	46.413.166	Saída do escapamento / exhaust pipe	CNAC	1	1	
40528	4.179.043	Tampa da árvore de manivelas	NA	1		
40529	4.302.267	Tampa da árvore de manivelas traseira	NA	1		
40515	4.195.119	Tampa do óleo	NA	1	1	
40538	4.179.138	Tampa do óleo	NA	1	1	
40539	7.770.023	Passagem d'água a tampa	NA	1		
40540	9.947.376	Borboleta ar	NA	1		
40541		Tampa comando de válvulas	NA	1	1	
40542		Válvula do termostato	NA	1		
40543		Tampa da bomba de óleo	LT	1	1	
40522	46.402.220	Coletor de admissão / intake manifold	BO	4	4	
40888B		Kit de borrachas / kit rubbers	KB	1	1	
R920010		Kit de retentores para motor completo				
R921001	7581344	Retentores de haste de válvulas 7x9,8x10	VI	16	16	
R924007	40000470	Retentor do comando de válvulas 30x52x7	SI	2	2	
R924008	40004960	Retentor do comando auxiliar de válvulas 30x47x7	SI	1	1	
R922004	46416876	Retentor traseiro do virabrequim flange	SI	1		
R924006	7628850	Retentor dianteiro do virabrequim 40x56x7	SI	1		

Itens Relacionados

Gaxeta

Juntas para Injeção Eletrônica

Retentores

Jogo de juntas para câmbio



JL40763
Gaxeta do escapamento Fiat (todos)

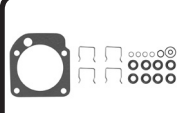

JL15708
Jogo de juntas I.E. Palio 16V Multipoint



R923002
Retentor traseiro virabrequim Fiat (antigo) 64x80x8 Ref.



JL40391
Jogo juntas câmbio Fiat todos 5 marchas

Em breve novidades

R920010

R921001 R924007

R924008 R922004 R924006

Fiat



Juntalima

Motor/Engine 1.6 16V 182B6.000
(Pistão de 80mm)

Códigos jogos de juntas
Code set gaskets

Modelo / Model Cm³ De Até

Brava	1596	2000	
Marea	1596	2000	
Palio	1596	2000	
Siena	1596	2000	

Completo com retentores 40403CR	Full set with oil seals 40403CR
Completo sem retentores 40403C	Full set without oil seals 40403C
Completo MLS com retentores 40403CMR	Full set MLS with oil seals 40403CMR
Completo MLS sem retentores 40403CM	Full set MLS without oil seals 40403CM
Kit retificação com retentores 40403KR	Head set with oil seals 40403KR
Kit retificação sem retentores 40403K	Head set without oil seals 40403K
Kit retificação MLS com retentores 40403KMR	MLS Head set with oil seals 40403KMR
Kit retificação MLS sem retentores 40403KM	MLS Head set without oil seals 40403KM

Código/Code	Nº Original	Aplicação / application	MP	C	K	M
40403G		Cabeçote / cylinder head gasket	PAK	1	1	
40403MLS		Cabeçote / cylinder head gasket	MLS			1
40229	4.773.831	Regulagem das válvulas	NA	2	2	2
40421	46.412.116	Coletor de escapamento / exhaust manifold	PAK	1	1	1
40422	46.410.505	Coletor de admissão / intake manifold	PAK	1	1	1
40516	4.179.038	Cárter / oil pan	CB	1		1
40523	46.413.166	Saída do escapamento / exhaust pipe	CNAC	1	1	1
40528	4.179.043	Tampa de árvore de manivelas	NA	1		1
40529	4.302.267	Tampa da árvore de manivelas traseira	NA	1		1
40515	4.195.119	Tampa do óleo	NA	1	1	1
40538	4.179.138	Tampa da bomba do óleo	NA	1	1	1
40539	7.770.023	Passagem d'água a tampa	NA	1		1
40540	9.947.376	Borboleta de ar	NA	1		1
40541		Tampa do comando de válvulas	NA	1	1	1
40542		Válvula do termostato	NA	1		1
40543		Tampa bomba de óleo	LT	1	1	1
40522	46.402.220	Jogo coletor de admissão	BO	4	4	4
40132		Coletor de admissão / intake manifold	BO	4	4	4
40888B		Kit de borrachas / kit rubbers	KB	1	1	1
R920010		Kit de retentores para motor completo				
R921001	7581344	Retentores de haste válvulas 7x9,8x10	VI	16	16	16
R924007	40000470	Retentor do comando de válvulas 30x52x7	SI	2	2	2
R924008	40004960	Retentor do comando auxiliar de válvulas 30x47x7	SI	1	1	1
R922004	46416876	Retentor traseiro do virabrequim flange	VI	1		1
R924006	7628850	Retentor dianteiro do virabrequim 40x56x7	SI	1		1

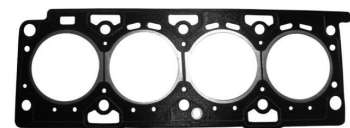

JL40403G

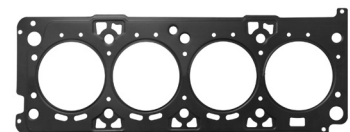

JL40403MLS



JL40229(x2)



JL40421



JL40422



JL40516



JL40523 JL40528 JL40529



JL40515 JL40538 JL40539



JL40540 JL40541 JL40542



JL40543 JL40522 JL40132

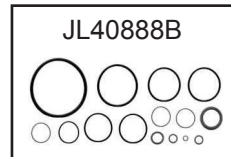

R920010



R921001 R924007



R924008 R922004 R924006

Itens Relacionados

Gaxeta

Juntas para Injeção Eletrônica

Retentores

Jogo de juntas para câmbio

JL40763
Gaxeta do escapamento Fiat (todos)

JL15708
Jogo de juntas I.E. Palio 16V Multipoint

R923002
Retentor traseiro virabrequim Fiat (antigo) 64x80x8 Ref.

JL40391
Jogo juntas câmbio Fiat todos 5 marchas

Em breve novidades

Fiat



Juntalima

Motor/Engine 1.6 16V Etorq Flex

Códigos jogos de juntas
Code set gaskets

Modelo / Model	Cm³	De	Até	Completo com retentores 40104CR	Full set with oil seals 40104CR
Palio Essence	1598	2011		Completo sem retentores 40104C	Full set without oil seals 40104C
Grand Siena Essence	1598	2011		Completo MLS com retentores 40104CMR	Full set MLS with oil seals 40104CMR
Punto Essence	1598	2011		Completo MLS sem retentores 40104CM	Full set MLS without oil seals 40104CM
Idea Essence	1598	2011		Kit retificação com retentores 40104KR	Head set with oil seals 40104KR
Strada Trekking	1598	2011		Kit retificação sem retentores 40104K	Head set without oil seals 40104K
Weekend Trekking	1598	2011		Kit retificação MLS com retentores 40104KMR	MLS Head set with oil seals 40104KMR
				Kit retificação MLS sem retentores 40104KM	MLS Head set without oil seals 40104KM

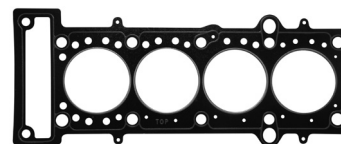

JL40104

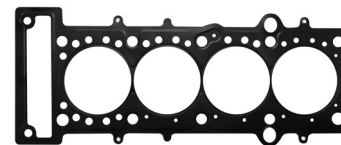

JL40104MLS

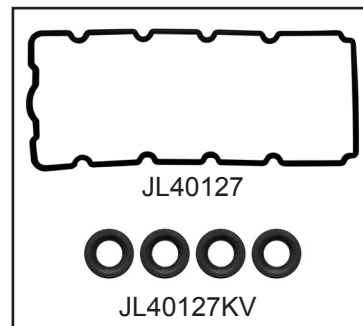

JL40127

JL40127KV

JL40127K



JL40723



JL40924

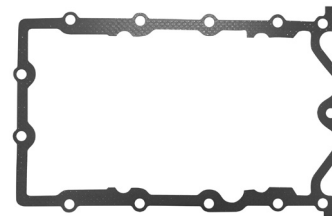

JL40717



JL40718



JL40110

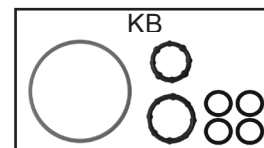

KB

Código/Code	N° Original	Aplicação / application	MP	C	K	M
40104		Cabeçote / cylinder head gasket	PAK	1	1	
40104MLS		Cabeçote / cylinder head gasket	MLS			1
40127		Tampa de válvulas	BO			
40127KV		Kit vedadores de velas	KT			
40127K		Kit tampa de válvulas com vedadores de velas	KT	1	1	1
40723		Coletor de admissão / intake manifold	BO	4	4	4
40924		Coletor de escapamento / exhaust manifold	CNAC	1	1	1
40717		Cárter / oil pan	PAK	1		1
40718	55231652	Suporte do filtro de óleo ao bloco	BO	1		1
40110		Sensor de temperatura da água	BO	1	1	1
KB		Kit de borrachas / kit rubbers	KB	1	1	1
R920009		Kit de retentores para motor completo				
R931001		Retentores de haste de válvulas 6x11x17,8	VI	16	16	16
R924003		Retentor do comando de válvulas 40x55x7	SI	1		1
R923004		Retentor traseiro do virabrequim 91x11x10	SI	1		
R924012		Retentor da polia 32x45x6	SI	1		



Juntalima
Indústria e Comércio de Auto Peças Ltda

**REFERÊNCIA NACIONAL
EM JUNTAS MLS**

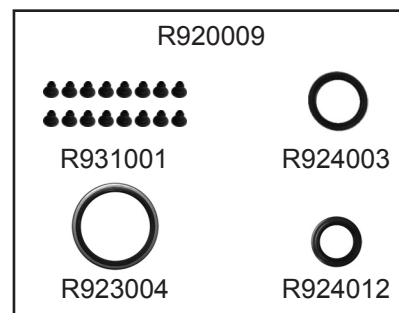

R920009

R931001

R924003

R923004

R924012

Fiat/ Jeep



Juntalima

Motor/Engine 1.8 16V Etorq Flex

Códigos jogos de juntas
Code set gaskets

Modelo / Model	Cm³	De	Até	Completo com retentores 40105CR	Full set with oil seals 40105CR
Punto	1747	2011		Completo sem retentores 40105C	Full set without oil seals 40105C
Bravo	1747	2011		Completo MLS com retentores 40105CMR	Full set MLS with oil seals 40105CMR
Línea	1747	2011		Completo MLS sem retentores 40105CM	Full set MLS without oil seals 40105CM
Wekkend Adventure	1747	2011		Kit retificação com retentores 40105KR	Head set with oil seals 40105KR
Strada Adventure	1747	2011		Kit retificação sem retentores 40105K	Head set without oil seals 40105K
Doblò Adventure	1747	2011		Kit retificação MLS com retentores 40105KMR	MLS Head set with oil seals 40105KMR
Idea Adventure	1747	2011		Kit retificação MLS sem retentores 40105KM	MLS Head set without oil seals 40105KM
Doblò Cargo	1747	2011			
Jeep Renegade	1747	2016			

Código/Code	Nº Original	Aplicação / application	MP	C	K	M
40105		Cabeçote / cylinder head gasket	PAK	1	1	1
40105MLS		Cabeçote / cylinder head gasket	MLS			1
40127		Tampa de válvulas	BO			
40127KV		Kit vedadores de velas	KT			
40127K		Kit tampa de válvulas com vedadores de velas	KT	1	1	1
40723		Coletor de admissão / intake manifold	BO	4	4	4
40924		Coletor de escapamento / exhaust manifold	CNAC	1	1	1
40717		Cárter / oil pan	PAK	1		1
40718	55231652	Suporte do filtro de óleo ao bloco	BO	1		1
40110		Sensor de temperatura da água	BO	1	1	1
KB		Kit de borrachas / kit rubbers	KB	1	1	1
R920009		Kit de retentores para motor completo				
R931001		Retentores de haste de válvulas 6x11x17,8	VI	16	16	16
R924003		Retentor do comando de válvulas 40x55x7	SI	1		1
R923004		Retentor traseiro do virabrequim 91x11x10	SI	1		
R924012		Retentor da polia 32x45x6	SI	1		

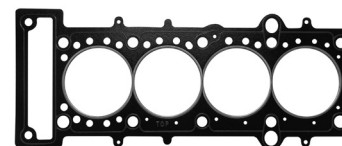

JL40105

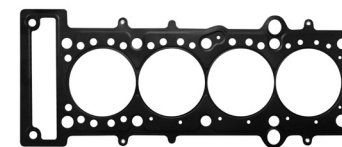

JL40105MLS

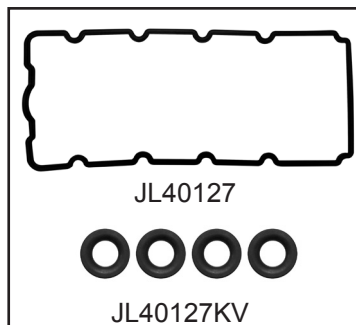

JL40127

JL40127KV

JL40127K



JL40723



JL40924

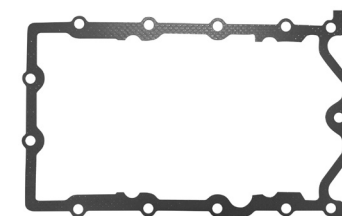

JL40717



JL40718



JL40110

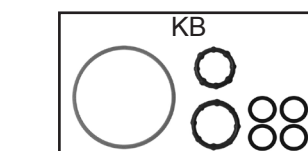

KB

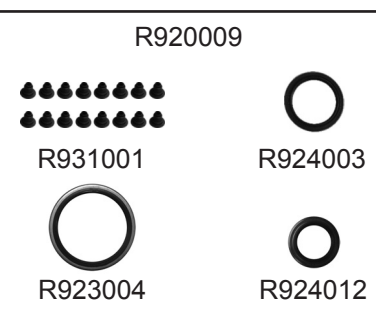

R920009



R931001



R924003



R923004



R924012

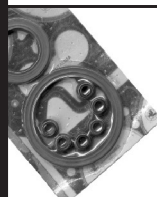

Juntalima
Indústria e Comércio de Auto Peças Ltda

CONHEÇA NOSSA LINHA DE RETENTORES



Fiat



Juntalima

Motor/Engine 1.8 16V 182A2

Códigos jogos de juntas
Code set gaskets

Modelo / Model	Cm³	De	Até	Completo com retentores 40901CR	Full set with oil seals 40901CR
Marea	1747	1995		Completo sem retentores 40901C	Full set without oil seals 40901C
Brava	1747	1995		Kit retificação com retentores 40901KR	Head set with oil seals 40901KR
				Kit retificação sem retentores 40901K	Head set without oil seals 40901K



JL40902AG

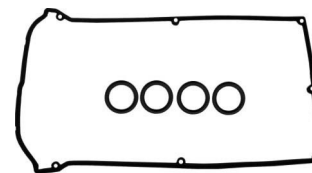

JL40936K



JL40923



JL40922



JL40917



JL40920



JL40965



JL40952



JL40953



JL40954



JL40955



JL40956



JL25026

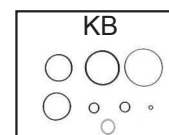

KB

Código/Code	N° Original	Aplicação / application	MP	C	K	M
40902AG	7.508.621	Cabeçote / cylinder head gasket	PAK	1	1	
40936K	68.069.090	Kit tampa de válvulas	BO	1	1	
40923	4.300.225	Coletor de escapamento / exhaust manifold	CNAC	1	1	
40922	4.309.031	Coletor de admissão / intake manifold	PAK	1	1	
40917	4.179.038	Cárter / oil pan	CB	1		
40920		Saída do escapamento / exhaust pipe	PAK	1	1	
40965	4.179.043	Guarnição	NA	1		
40952	4.302.267	Guarnição	NA	1		
40953	4.179.154	Guarnição	NA	1		
40954	4.179.155	Guarnição	NA	1		
40955	4.193.959	Guarnição	NA	1		
40956	4.198.159	Guarnição	NA	1		
25026		Arruela 20x26x1,5	AL	1		
KB	4.179.117	Kit de borrachas / kit rubbers	KB	1		
R920006		Kit de retentores para motor completo				
R921001	7581344	Retentores de haste de válvulas 7x9,8x10	VI	16	16	
R924002	40004240	Retentor do comando de válvulas 30x42x7	SI	2	2	
R924005	6081114	Retentor do comando de válvulas 55x68x8	SI	1	1	
R922003	60814374	Retentor traseiro do virabrequim flange	SI	1		
R924004	7628850	Retentor dianteiro do virabrequim 31x41x7	SI	1		

Itens Relacionados

Retentores



R923001
Retentor traseiro
do virabrequim
74x90x10

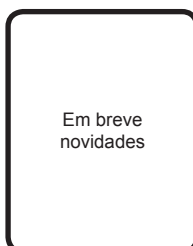

Em breve
novidades

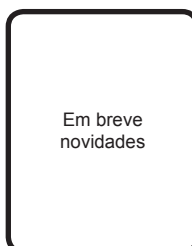

Em breve
novidades

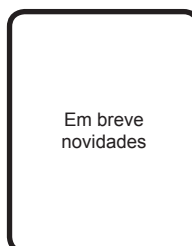

Em breve
novidades

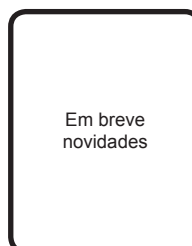

Em breve
novidades

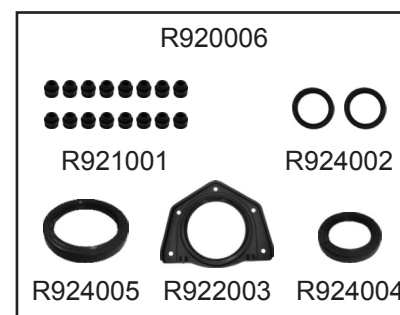

R920006

R921001

R924002



R924005



R922003



R924004

Fiat



Juntalima

Motor/Engine 1.8 16V 192.41x.0 (DOHC)

Códigos jogos de juntas
Code set gaskets

Modelo / Model	Cm³	De	Até	Completo com retentores 40904CR	Full set with oil seals 40904CR
Stilo	1781	2002		Completo sem retentores 40904C	Full set without oil seals 40904C
				Completo MLS com retentores 40904CMR	Full set MLS with oil seals 40904CMR
				Completo MLS sem retentores 40904CM	Full set MLS without oil seals 40904CM
				Kit retificação com retentores 40904KR	Head set with oil seals 40904KR
				Kit retificação sem retentores 40904K	Head set without oil seals 40904K
				Kit retificação MLS com retentores 40904KMR	MLS Head set with oil seals 40904KMR
				Kit retificação MLS sem retentores 40904KM	MLS Head set without oil seals 40904KM

Código/Code	N° Original	Aplicação / application	MP	C	K	M
10904	90.511.490	Cabeçote / cylinder head gasket	PAK	1	1	
10904MLS	90.511.490	Cabeçote / cylinder head gasket	MLS			1
40327	70.83.391	Tampa de válvulas / rocker cover gasket	BO	1	1	1
10221	90.470.036	Coletor de escapamento / exhaust manifold	CNAC	1	1	1
10823		Coletor de admissão / intake manifold	CNAC	1	1	1
10316	90.412.846	Cárter / oil pan	BO	1		1
10822F	90.231.452	Saída do escapamento / exhaust pipe	CNAC	1	1	1
10229	90.353.564	Bomba de óleo / oil pump	NA	1		1
10711	90.500.068	Coletor de admissão / intake manifold	NA	1		1
10713		Tubo de engrenagem / tube gear	PAK	1		1
KA001		Kit de borrachas e arruelas / rubbers and washers	KA	1	1	1
JLKB012		Kit de borrachas / kit rubbers	KB	1	1	1
JLKB011		Kit de borrachas / kit rubbers	KB	1	1	1
R910002		Kit de retentores para motor completo				
R911002	36109675	Retentores de hastes de válvulas 6x8,8x12	VI	16	16	16
R914002	90180529	Retentor do comando de válvulas 35x48x7	SI	2	2	2
R913001	90233236/90352111	Retentor traseiro do virabrequim 80x98x10	SI	1		1
R914001	90233235	Retentor dianteiro do virabrequim 26x42x8	SI	1		1

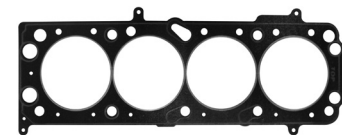

JL10904

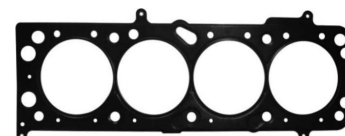

JL10904MLS

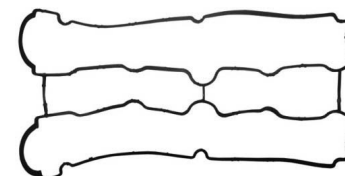

JL40327



JL10221

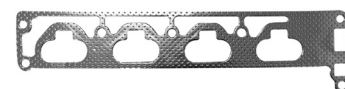

JL10823



JL10316



JL10822F

JL10229

JL10711

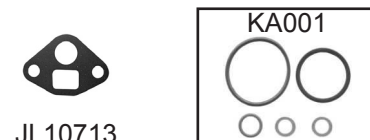

KA001

JL10713

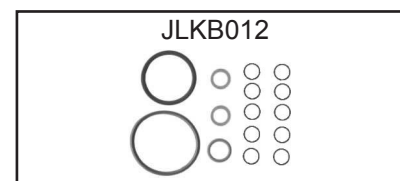

JLKB012

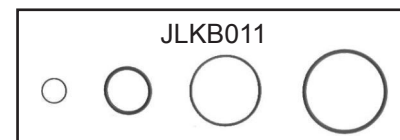

JLKB011

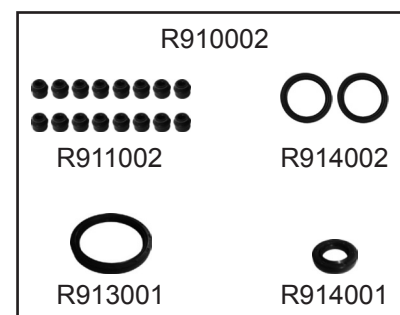

R910002

R911002

R914002

R913001

R914001

Itens Relacionados

Juntas para
Bomba d'água

JL10229MLS
Junta bomba do óleo
Corsa/celta/meriva
1.0/1.4/1.6/1.8 8/16V

JL10121
Jogo coletor admis-
são Corsa/Celta/
Meriva1.0/1.8

Em breve
novidades

Em breve
novidades

Em breve
novidades

Fiat



Juntalima

Motor/Engine 1.9 16V Flex

Códigos jogos de juntas
Code set gaskets

Modelo / Model	Cm³	De	Até
Linea	1838	2007	

Completo com retentores 40103CR	Full set with oil seals 40103CR
Completo sem retentores 40103C	Full set without oil seals 40103C
Kit retificação com retentores 40103KR	Head set with oil seals 40103KR
Kit retificação sem retentores 40103K	Head set without oil seals 40103K

Código/Code	N° Original	Aplicação / application	MP	C	K	M
40401G	46.410.960	Cabeçote / cylinder head gasket	PAK	1	1	
40229	4.773.831	Regulagem das válvulas	NA	2	2	
40421	46.412.116	Coletor de escapamento / exhaust manifold	PAK	1	1	
40422	46.410.505	Coletor de admissão / intake manifold	PAK	1	1	
40217	4.179.038	Cárter / oil pan	CB	1		
40523	46.413.166	Saída do escapamento / exhaust pipe	CNAC	1	1	
40322AF		Saída do escapamento / exhaust pipe	CNAC	1	1	
40528	4.179.043	Tampa da árvore manivelas	NA	1		
40529	4.302.267	Tampa da árvore manivela traseira	NA	1		
40515	4.195.119	Tampa do óleo	NA	1	1	
40538	4.179.138	Tampa bomba do óleo	NA	1	1	
40539	7.770.023	Passagem d'água a tampa	NA	1		
40540	9.947.376	Borboleta ar	NA	1		
40541		Tampa do comando de válvulas	NA	1	1	
40542		Válvula do termostato	NA	1		
40543		Tampa bomba de óleo	LT	1	1	
40888B		Kit de borrachas / kit rubbers	KB	1	1	
R920010		Kit de retentores de haste de válvulas 7x9,8x10	VI	16	16	
R924007	40000470	Retentor do comando de válvulas 30x52x7	SI	2	2	
R924008	40004960	Retentor do comando auxiliar de válvulas 30x47x7	SI	1	1	
R922004	46416876	Retentor traseiro do virabrequim flange	VI	1		
R924006	7628850	Retentor dianteiro do virabrequim 40x56x7	SI	1		

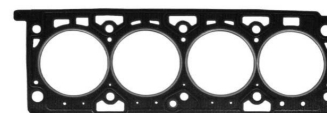

JL40401G



JL40229(x2)



JL40421



JL40422

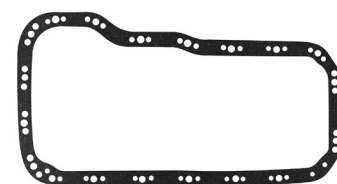

JL40217



JL40523



JL40322AF



JL40528



JL40529



JL40515



JL40538



JL40539



JL40540



JL40541



JL40542



JL40543

JL40888B

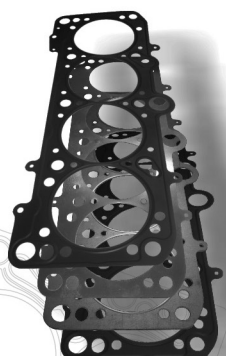

Juntalima
Indústria e Comércio de Auto Peças Ltda

**REFERÊNCIA NACIONAL
EM JUNTAS MLS**

R920010		
R921001		
R924007		
R924008	R922004	R924006

Fiat



Juntalima

Motor/Engine 2.0 8V 159A5.046

Códigos jogos de juntas
Code set gaskets

Modelo / Model	Cm³	De	Até	Completo com retentores 40206CR	Full set with oil seals 40206CR
Tipo I.E.	1995	1990	1995	Completo sem retentores 40206C	Full set without oil seals 40206C
Tempra I.E.	1995	1990	1995	Kit retificação com retentores 40206KR Kit retificação sem retentores 40206K	Head set with oil seals 40206KR Head set without oil seals 40206K

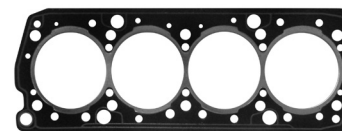

JL40201AG



JL40224(x2)



JL40226(x2)



JL40221A



JL40221B

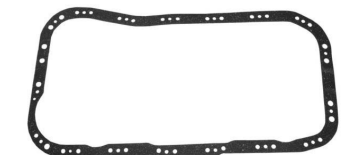

JL40216



JL40237F

JL40236



JL40228

JL40000



JL40230

JL40225



JL40231

JL40957



JL40247

JL40537

JL46247

Código/Code	Nº Original	Aplicação / application	MP	C	K	M
40201AG	7.709.257	Cabeçote / cylinder head gasket	PAK	1	1	
40224	7.676.324	Cabeçote superior	NA	2	2	
40226	7.715.789	Tampa de válvulas / rocker cover gasket	BO	2	2	
40221A		Coletor de admissão / escapamento	PAK	1	1	
40221B		Coletor de admissão / escapamento	PAK	1	1	
40216	7.646.248	Cárter / oil pan	CB	1		
40237F	7.703.015	Saída do escapamento / exhaust pipe	CNAC	1	1	
40236	7.625.508	Bomba de óleo / oil pump	NA	1		
40228	4.129.763	Tampa árvore do mancal	NA	1		
40000	7.748.504	Inspeção d'água ao bloco	NA	1		
40230	4.475.631	Bomba d'água / water pump	NA	1		
40225	7.628.319	Tampa lateral do cabeçote	NA	1		
40231	7.625.514	Bocal	NA	1		
40957		Resp. do motor	NA	1		
40247	7.701.854	Base termostato	NA	1		
40537	4.158.100	Bomba de gasolina / gasoline pump	NA	1		
46247	F70Z6675AA	Anel do bujão cárter 14x20	AL	1		
R920011		Kit de retentores para motor completo				
R921003	7553637	Retentores de haste de válvulas 8x10,8x10,3	VI	8	8	
R924007	40000470	Retentor do comando de válvulas 30x52x7	SI	1	1	
R923001	40004300	Retentor traseiro do virabrequim 74x90x10	SI	1		
R924009	4005016	Retentor dianteiro do virabrequim 30x43x8	SI	1		

Itens Relacionados

Juntas para
Carburador

Juntas para
Injeção Eletrônica

JL40251
Jg juntas carburador
Tempra 2.0 8V Uno

JL15705
Jg de juntas para I.E.
Tempra 2.0
singlepoint S.P.I.

Em breve
novidades

Em breve
novidades

Em breve
novidades

R920011

R921003 R924007

R923001 R924009

Fiat



Juntalima

Motor/Engine 2.0 16V (Zact)

Códigos jogos de juntas
Code set gaskets

Modelo / Model	Cm³	De	Até	Completo com retentores 40207CR	Full set with oil seals 40207CR
Tempira (DOHC)	1995	1992		Completo sem retentores 40207C	Full set without oil seals 40207C
Tipo	1995	1993	1996	Kit retificação com retentores 40207KR Kit retificação sem retentores 40207K	Head set with oil seals 40207KR Head set without oil seals 40207K

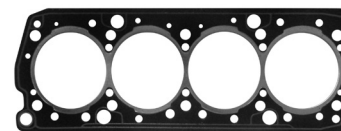

JL40201AG

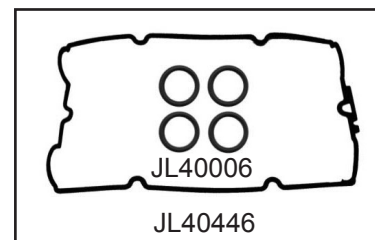

JL40446

JL40446K



JL40220



JL40122



JL40216



JL40239



JL40236



JL40228



JL40215



JL40430



FT015(x2)



JL40247



JL40957



JL46247

Código/Code	N° Original	Aplicação / application	MP	C	K	M
40201AG	7.709.257	Cabeçote / cylinder head gasket	PAK	1	1	
40006		borracha de vedação da tampa de válvulas	BO	4	4	
40446	7.766.412	Tampa de válvulas / rocker cover gasket	BO	1	1	
40446K		Kit tampa de válvulas e borracha de vedação	KIT			
40220	7.700.581	Coletor de escapamento / exhaust manifold	PAK	1	1	
40122	7.668.195	Coletor de admissão / intake manifold	PAK	1	1	
40216	7.646.248	Cárter / oil pan	CB	1		
40239	7.700.578	Saída do escapamento / exhaust pipe	PAK	1	1	
40236	7.625.508	Bomba de óleo / oil pump	NA	1		
40228	4.129.763	Tampa árvore do mancal	NA	1		
40215	7.625.510	Carcaça da bomba de óleo	NA	1	1	
40430	7.679.976	Bomba d'água / water pump	NA	1		
FT015	7.703.016	Suporte da turbina	NA	2		
40247	7.701.854	Base termostato	NA	1		
40957	F70Z6675AA	Guarnição	NA	1		
46247		Anel do bujão do cárter 14x20	AL	1		
R920012		Kit de retentores para motor completo				
R921001	7581344	Retentores de haste de válvulas	VI	16	16	
R924007	40000470	Retentor do comando de válvulas 30x52x7	SI	2	2	
R923001	40004300	Retentor traseiro do virabrequim 74x90x10	SI	1		
R924009	40005016	Retentor dianteiro do virabrequim 30x43x8	SI	1		

Itens Relacionados

Juntas para Injeção Eletrônica

Juntas para Injeção Eletrônica

Juntas para Injeção Eletrônica

Juntas para Injeção Eletrônica

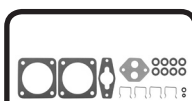

JL15702
Jg juntas para I.E.
Tempira 2.0 16V
Multipoint



JL15703
Jg juntas para I.E.
Tempira 2.0 16V
Multipoint (Anel viton)



JL15705
Jg juntas para I.E.
Tempira 2.0
singlepoint S.P.I.

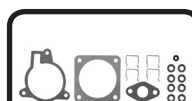

JL15706
Jg juntas para I.E.
Tempira 2.0 16V 94
IAW P8 multipoint

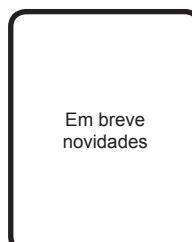

Em breve novidades

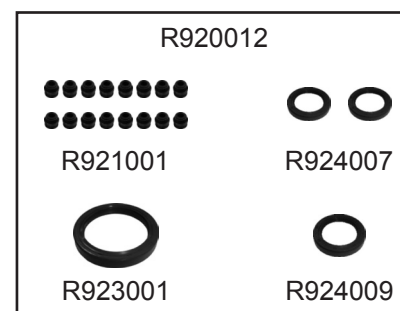

R921001

R924007

R923001

R924009

Fiat



Juntalima

Motor/Engine 2.0 20V 182A1

Códigos jogos de juntas
Code set gaskets

Modelo / Model	Cm³	De	Até	Completo com retentores 40402CR	Full set with oil seals 40402CR
Marea	1998	1996		Completo sem retentores 40402C	Full set without oil seals 40402C
Coupe	1998	1996	2001	Kit retificação com retentores 40402KR	Head set with oil seals 40402KR
Brava	1998	1995	1998	Kit retificação sem retentores 40402K	Head set without oil seals 40402K

Código/Code	N° Original	Aplicação / application	MP	C	K	M
40805AG	77.662.68	Cabeçote / cylinder head gasket	PAK	1	1	
40926	77.662.36/77.154.92	Tampa de válvulas / rocker cover gasket	BO			
40926K	77.662.36/77.154.92	Kit tampa de válvulas e vedadores	KT		1	
40123	46.525.557	Coletor de escapamento / exhaust manifold	CNAC	1	1	
40222	46.527.523	Coletor de admissão / intake manifold	PAK	1	1	
40716		Cárter / oil pan	CB	1		
40136	77.742.33	Bomba de óleo / oil pump	NA	1		
40137	71.718.365	Guarnição	CB	1		
40158		Guarnição	NA	1		
40952	60.605.353	Guarnição	NA	1		
40003	82.473.601	Catalizador	CNAC	1	1	
KB		Kit de borrachas e arruelas / rubbers and washers	KB	1		
R920005		Kit de retentores para motor completo				
R921001	7581344	Retentor de haste de válvulas	VI	20	20	
R924002	40004240	Retentor do comando de válvulas 30x42x7	SI	1	1	
R924005	60811144	Retentor do comando de válvulas 55x68x8	SI	1	1	
R922003	60814374	Retentor traseiro do virabrequim flange	VI	1		
R924004	7628850	Retentor dianteiro do virabrequim 31x41x7	SI	1		

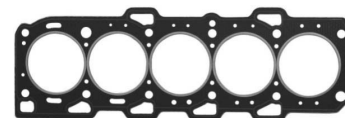

JL40805AG

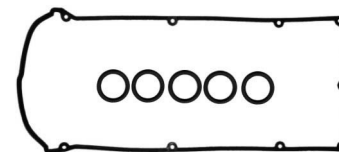

JL40926K



JL40123



JL40222



JL40716



JL40136



JL40137



JL40158



JL40952



JL40003

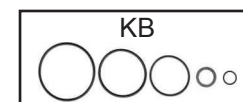

Itens Relacionados

Juntas para Injeção Eletrônica

JL15713
Jg juntas para I.E.
Marea SW 2.0 20V
5cc Multipoint

Em breve novidades

Em breve novidades

Em breve novidades

Em breve novidades

R920005

R921001 R924002

R924005 R922003 R924004

Fiat



Juntalima

Motor/Engine 2.3 16V JTD F1AE0481C

Códigos jogos de juntas
Code set gaskets

Modelo / Model	Cm³	De	Até	Completo com retentores 40806CR	Full set with oil seals 40806CR
Ducato JTD	2286	2002		Completo sem retentores 40806C	Full set without oil seals 40806C
Ducato JTD	2286	2006		Completo MLS com retentores 40806CMR	Full set MLS with oil seals 40806CMR
				Completo MLS sem retentores 40806CM	Full set MLS without oil seals 40806CM
				Kit retificação com retentores 40806KR	Head set with oil seals 40806KR
				Kit retificação sem retentores 40806K	Head set without oil seals 40806K
				Kit retificação MLS com retentores 40806KMR	MLS Head set with oil seals 40806KMR
				Kit retificação MLS sem retentores 40806KM	MLS Head set without oil seals 40806KM

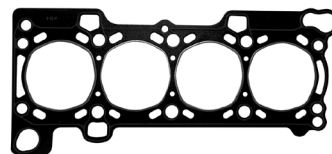

JL40806

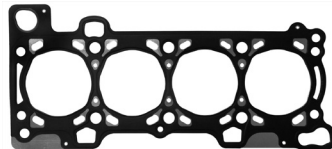

JL40806MLS

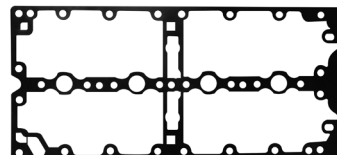

JL40836MLS



JL40822



JL40823MLS



JL40817



JL40818

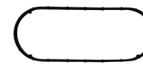

JL40819



JL40828

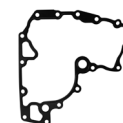

JL40829MLS



JL40824



JL40825(x5)



JL016424



JL40820



JL40838

Código/Code	N° Original	Aplicação / application	MP	C	K	M
40806		Cabeçote / cylinder head gasket	PAK	1	1	
40806MLS		Cabeçote / cylinder head gasket	MLS			1
40836MLS		Tampa de válvulas / rocker cover gasket	MLS	1	1	1
40822		Coletor de escapamento / exhaust manifold	PAK	1	1	1
40823MLS		Coletor de admissão / intake manifold	MLS	1	1	1
40817		Cárter / oil pan	BO	1		1
40818		Semi cárter	BO	1		1
40819		Guarnição	BO	1		1
40828		Bomba de óleo / oil pump	GV	1		1
40829MLS		Tampa da distribuição / timing cover	MLS	1		1
40824		Turbina	CNAC	1	1	1
40825		Kit da turbina	CNAC	5	5	5
016424		Entre coletor de escapamento / Turbina	CNAC	1	1	1
40820		Guarnição	PAK	1		1
40838		Guarnição	GV	1		1
KA		Kit de arruela	AL	1	1	1
KB		Kit de borrachas / kit rubbers	BO	1	1	1



Juntalima
Indústria e Comércio de Auto Peças Ltda

**REFERÊNCIA NACIONAL
EM JUNTAS MLS**

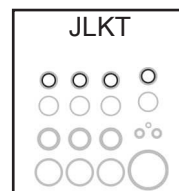

JLKT

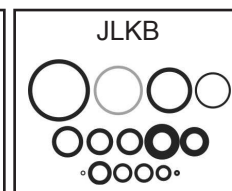

JLKB



Motor/Engine 2.4 16V ED3

Códigos jogos de juntas
Code set gaskets

Modelo / Model	Cm³	De	Até	Completo com retentores 40808CR	Full set with oil seals 40808CR
Freemont	2360	2011	2016	Completo sem retentores 40808C	Full set without oil seals 40808C
Journey	2360	2009	2016	Completo MLS com retentores 40808CMR	Full set MLS with oil seals 40808CMR
Avenger	2360	2007	2016	Completo MLS sem retentores 40808CM	Full set MLS without oil seals 40808CM
				Kit retificação com retentores 40808KR	Head set with oil seals 40808KR
				Kit retificação sem retentores 40808K	Head set without oil seals 40808K
				Kit retificação MLS com retentores 40808KMR	MLS Head set with oil seals 40808KMR
				Kit retificação MLS sem retentores 40808KM	MLS Head set without oil seals 40808KM

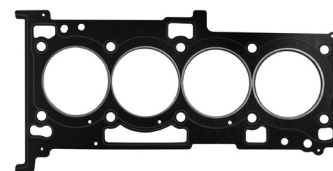

JL40808

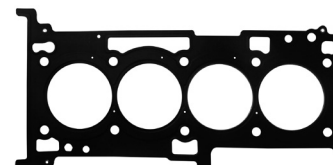

JL40808MLS

Código/Code	N° Original	Aplicação / application	MP	C	K	M
40808	10177100	Cabeçote / cylinder head gasket	PAK	1		
40808MLS	10177100	Cabeçote / cylinder head gasket	MLS		1	1
40827K	56040800	Kit vedadores e tampa de válvulas	KIT	1	1	1
40831	13216200	Coletor de admissão / intake manifold	BO	1	1	1
40832	13216300	Coletor de escapamento / exhaust manifold	CNAC	1	1	1
40891		Guarnição	MLS	1		1
40892		Guarnição	MLS	1		1
KB058		Kit de borrachas / kit rubbers	KB	1	1	1
R920013		Kit de retentores para motor completo				
R921005	12025500	Retentores de haste de válvulas 4,5X10,8X19,8	BO	16	16	16
R924013	15056500	Retentor do comando de válvulas 42X55X7	BO	1	1	1
R743006	15052700	Retentor traseiro do virabrequim 85X103X8	BO	1		1

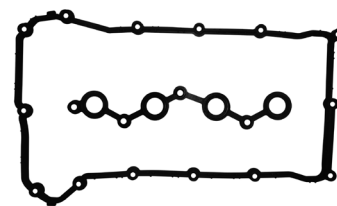

JL40827K



JL40831



JL40832



JL40891



JL40892

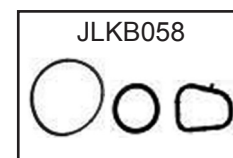

JLKB058

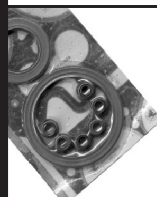

Juntalima
Indústria e Comércio de Auto Peças Ltda

CONHEÇA NOSSA LINHA DE RETENTORES

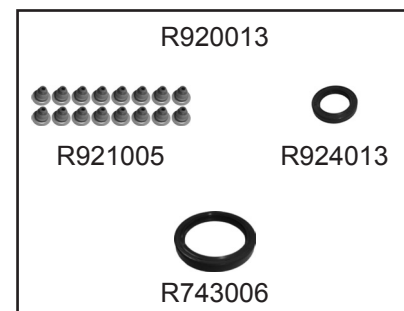

Fiat



Juntalima

Motor/Engine 2.4 20V

Códigos jogos de juntas
Code set gaskets

Modelo / Model	Cm³	De	Até
Marea	2445	2001	

Completo com retentores
40902CR
Completo sem retentores
40902C
Kit retificação com retentores
40902KR
Kit retificação sem retentores
40902K

Full set with oil seals
40902CR
Full set without oil seals
40902C
Head set with oil seals
40902KR
Head set without oil seals
40902K

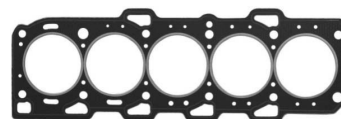

JL40805AG

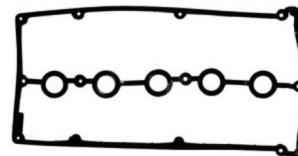

JL40126



JL40123



JL40222



JL40716



JL40136



JL40137



JL40158



JL40952



JL40003



Código/Code	N° Original	Aplicação / application	MP	C	K	M
40805AG	77.662.68	Cabeçote / cylinder head gasket	PAK	1	1	
40126		Tampa de válvulas / rocker cover gasket	BO	1	1	
40123	46.525.557	Coletor de escapamento / exhaust manifold	CNAC	1	1	
40222	46.527.523	Coletor de admissão / intake manifold	PAK	1	1	
40716		Cárter / oil pan	CB	1		
40136	77.742.33	Bomba de óleo / oil pump	NA	1		
40137	71.718.365	Guarnição	NA	1		
40158		Guarnição	NA	1		
F028	60.605.353	Guarnição	NA	1		
40003	82.473.601	Catalizador	CNAC	1	1	
KB		Kit de borrachas e arruelas / rubbers and washers	KB	1		
R920005		Kit de retentores para motor completo				
R921001	7581344	Retentores de haste de válvulas	VI	20	20	
R924002	40004240	Retentor do comando de válvulas 30x42x7	SI	1	1	
R924005	60811144	Retentor do comando de válvulas 55x68x8	SI	1	1	
R922003	60814374	Retentor traseiro do virabrequim flange	VI	1		
R924004	7628850	Retentor dianteiro do virabrequim 31x41x7	SI	1		

Itens Relacionados

Juntas para Injeção Eletrônica

JL15713
Jg juntas para I.E.
Marea SW 2.0 20V
5cc Multipoint

Em breve novidades

Em breve novidades

Em breve novidades

Em breve novidades

R920005

R921001 R924002
R924005 R922003 R924004



Motor/Engine 2.5 8V 8140.67X230
2.5 8V 8140.67F37

Códigos jogos de juntas
Code set gaskets

Modelo / Model Cm³ De Até

Fiat Ducato 2499 1994
Iveco Daily 30.8-35.8 2499 1996

Completo com retentores 016121CR	Full set with oil seals 016121CR
Completo sem retentores 016121C	Full set without oil seals 016121C
Completo c/ retentores s/ cabeçote 016121SCR	Full set w/o cyl. head gasket with oil seals 016121SCR
Completo sem cabeçote 016121SC	Full set without cyl. head gasket 016121SC
Kit retificação com retentores 016121KR	Head set with oil seals 016121KR
Kit retificação sem retentores 016121K	Head set without oil seals 016121K
Kit sem cabeçote com retentores 016121KSCR	Head set w/o cyl. head gasket seals 016121KSCR
Kit retificação sem cabeçote 016121KSC	Head set without cyl. head gasket 016121KSC

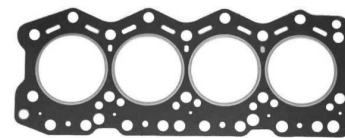

JL016121

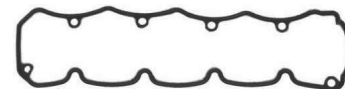

JL016127



JL016322(x4) JL016422(x4)

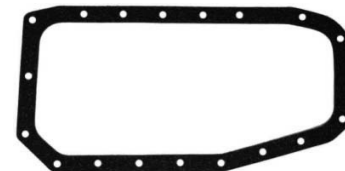

JL016116

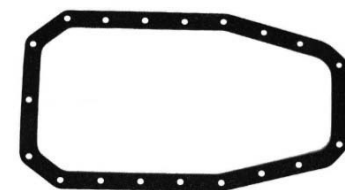

JL016227



JL016423 JL016424 JL016425



JL016447 JL016448 JL016449



JL016450 JL016451 JL016452



JL016453 JL016488 JL016454



JL016455 JL016456 JL016458

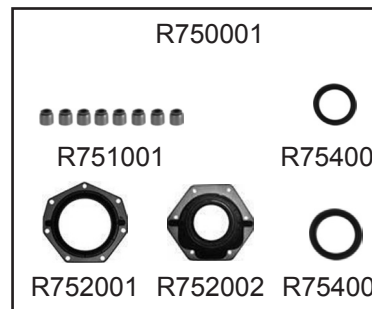
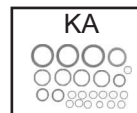
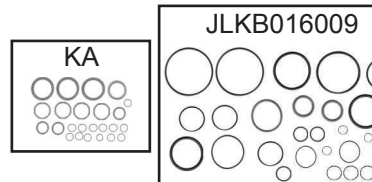

Código/Code	Nº Original	Aplicação / application	MP	C	K	M
016121	98.492.589	Cabeçote / cylinder head gasket	PAK	1	1	
016127	500.388.382	Tampa de válvulas / rocker cover gasket	BO	1	1	
016322	98.425.767	Coletor de admissão / intake manifold	CNAC	4	4	
016422	98.434.020	Coletor de escapamento / exhaust manifold	CNAC	4	4	
016116		Cárter / oil pan	CB	1		
016227		Cárter / oil pan	CB	1		
016423		Coletor de escapamento / turbina	CNAC	1	1	
016424		Entre coletor de escapamento / turbina	CNAC	1	1	
016425		Coletor de escapamento / turbina	CNAC	1	1	
016447		Distribuição	NA	1		
016448		Tampa virabrequim	NA	1		
016449		Tampa traseira	NA	1		
016450		Tampa traseira do bloco	NA	1		
016451		Carcaça termostato	GV	1	1	
016452		Comando da bomba injetora	NA	1	1	
016453		Porta do termostato	NA	1	1	
016488		Guarnição	NA	1	1	
016454		Base do filtro de óleo	NA	1		
016455		Bomba injetora	NA	1	1	
016456		Flange d'água	NA	1	1	
016458		Termostato	CB	1		
KA		Kit de arruelas / kit washers	KA	1		
JLKB016009		Kit de borrachas / kit rubbers	KB	1		
R750001		Kit de retentores para motor completo				
R751001		Retentores de Haste de Válvulas	VI	8	8	
R754002		Retentor do comando de válvulas 50x70x10	SI	1	1	
R752001		Flange traseira	SI	1		
R752002		Flange dianteira	SI	1		
R754003		Eixo intermediário 55x70x8	SI	1	1	

Itens Relacionados

Juntas do Cabeçote

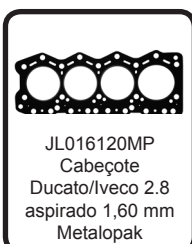

Em breve novidades

Em breve novidades

Em breve novidades

Em breve novidades



Motor/Engine 2.8 8V 8140.43 S9W 700
2.8 8V 8140.43 S9W 702

Códigos jogos de juntas
Code set gaskets

Modelo / Model Cm³ De Até

Fiat Ducato 14TDS	2799	1996	2002
Fiat Ducato Maxi 18 TDS	2799	1996	2002
Renault Master TD	2799	1998	

Completo com retentores 016120CR	Full set with oil seals 016120CR
Completo sem retentores 016120C	Full set without oil seals 016120C
Completo c/ retentores s/ cabeçote 016121SCR	Full set w/o head gasket with oil seals 016121SCR
Completo sem cabeçote 016121SC	Full set without cyl. head gasket 016121SC
Completo MLS com retentores 016120KR	Full set MLS with oil seals 016120KR
Completo MLS sem retentores 016120K	Full set MLS without oil seals 016120K
Kit sem cabeçote com retentores 016121KSCR	Head set w/o head gasket with seals 016121KSCR
Kit retificação sem cabeçote 016121KSC	Head set without cyl. head gasket 016121KSC

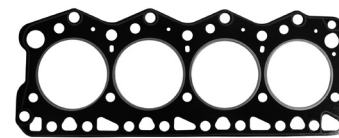

JL016122MP

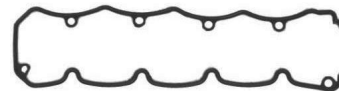

JL016127



JL016322(x4) JL016422(x4)

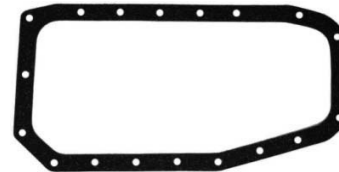

JL016116

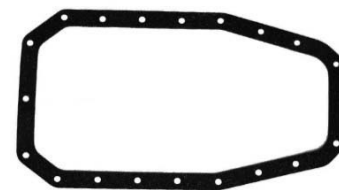

JL016227



JL016423 JL016424 JL016425



JL016447 JL016448 JL016449



JL016450 JL016451 JL016452



JL016453 JL016488 JL016454



JL016455 JL016456 JL016458

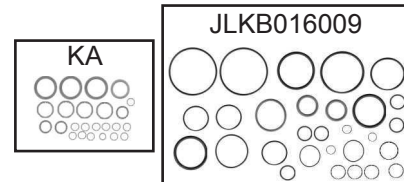

JLKB016009

Código/Code	N° Original	Aplicação / application	MP	C	K	M
016122MP	500.306.170	Cabeçote / cylinder head gasket Metalopak	MPAK	1	1	
016127	500.388.382	Tampa de válvulas / rocker cover	BO	1	1	
016322	98.425.767	Coletor de admissão / intake manifold	CNAC	4	4	
016422	98.434.020	Coletor de escapamento / exhaust manifold	CNAC	4	4	
016116		Cárter / oil pan	CB	1		
016227		Cárter / oil pan	CB	1		
016423		Coletor de escapamento / turbina	CNAC	1	1	
016424		Entre coletor de escapamento / Turbina	CNAC	1	1	
016425		Coletor de escapamento / turbina	CNAC	1	1	
016447		Distribuição	NA	1		
016448		Tampa virabrequim	NA	1		
016449		Tampa traseira	NA	1		
016450		Tampa traseira do bloco	NA	1		
016451		Carcaça termostato	GV	1	1	
016452		Comando da bomba injetora	NA	1	1	
016453		Porta do termostato	NA	1	1	
016488		Guarnição	NA	1	1	
016454		Base do filtro de óleo	NA	1		
016455		Bomba injetora	NA	1	1	
016456		Flange d'água	NA	1		
016458		Termostato	CB	1		
JLKB016009		Kit de borrachas / kit rubbers	KB	1		
KA		Kit de arruelas / kit washers	KB	1		
R750001		Kit de Retentores para Motor Completo				
R751001		Retentores de Haste de Válvulas	VI	8	8	
R754002		Retentor do comando de válvulas 50x70x10	SI	1	1	
R752001		Flange traseira	SI	1		
R752002		Flange dianteira	SI	1		
R754003		Eixo intermediário 55x70x8	SI	1	1	

Itens Relacionados

Juntas para Cabeçote

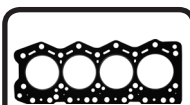

JL016120MP
Cabeçote
Ducato/Iveco 2.8
aspirado 1,60 mm
Metalopak

Em breve novidades

Em breve novidades

Em breve novidades

Em breve novidades

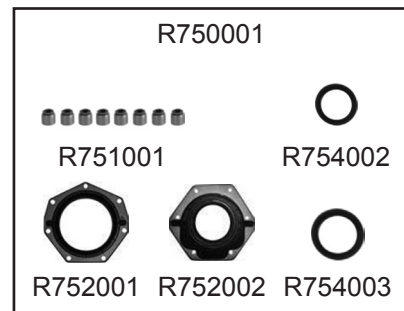

R750001

R751001

R754002

R752001

R752002

R754003



Motor/Engine 2.8 8V 8140.43S

Códigos jogos de juntas
Code set gaskets

Modelo / Model	Cm³	De	Até	Completo com retentores 016122CR	Full set with oil seals 016122CR
Fiat Ducato JTD	2799	1994	2005	Completo sem retentores 016122C	Full set without oil seals 016122C
Daily City JTD	2799	2007		Kit retificação com retentores 016122KR	Head set with oil seals 016122KR
				Kit retificação sem retentores 016122K	Head set without oil seals 016122K
				Completo sem cabeçote 016122SC	Full set without cyl. head gasket 016122SC
				Completo s/cabeçote c/retentores 016122SCR	Full set w/o cyl. head gasket with seals 016122SCR
				Kit retificação sem cabeçote 016122KSC	Retification kit without head gasket 016122KSC
				Kit s/cabeçote c/retentores 016122KSCR	Head set w/o head gasket with seals 016122KSCR

Código/Code	Nº Original	Aplicação / application	MP	C	K	M
016122MP	500.306.170	Cabeçote / cylinder head gasket Metalopak	MPAK	1	1	
016128	98.425.767	Tampa de válvulas / rocker cover gasket	BO	1	1	
016322	98.425.767	Coletor de admissão / intake manifold	CNAC	4	4	
016422	98.434.020	Coletor de escapamento / exhaust manifold	CNAC	4	4	
016116		Cárter / oil pan	CB	1		
016227		Cárter / oil pan	CB	1		
016423		Coletor de escapamento / turbina	CNAC	1	1	
016424		Entre coletor de escapamento / Turbina	CNAC	1	1	
016425		Coletor de escapamento / turbina	CNAC	1	1	
016447		Distribuição	NA	1		
016448		Tampa virabrequim	NA	1		
016449		Tampa traseira	NA	1		
016450		Tampa traseira do bloco	NA	1	1	
016451		Carcaça termostato	GV	1	1	
016452		Comando da bomba injetora	NA	1	1	
016453		Porta do termostato	NA	1	1	
016488		Guarnição	NA	1	1	
016454		Base do filtro de óleo	NA	1		
016455		Bomba injetora	NA	1	1	
016456		Flange d'água	NA	1	1	
016458		Termostato	CB	1		
JLKB016009		Kit de borrachas / kit rubbers	KB	1		
KA		Kit de arruelas / kit washers	KA	1		
R750001		Kit de Retentores para Motor Completo				
R751001		Retentores de Haste de Válvulas	SI	8	8	
R754002		Retentor do comando de válvulas 50x70x10	SI	1	1	
R752001		Flange traseira	SI	1		
R752002		Flange dianteira	SI	1		
R754003		Eixo intermediário 55x70x8	SI	1	1	

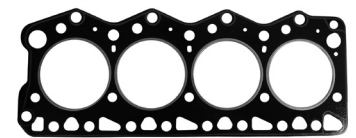

JL016122MP



JL016128



JL016322(x4) JL016422(x4)



JL016116

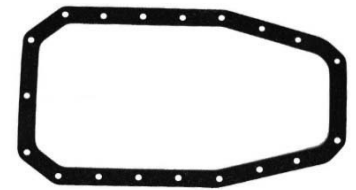

JL016227



JL016423 JL016424 JL016425



JL016447 JL016448 JL016449



JL016450 JL016451 JL016452



JL016453 JL016488 JL016454



JL016455 JL016456 JL016458

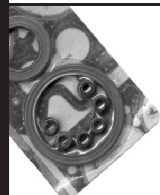
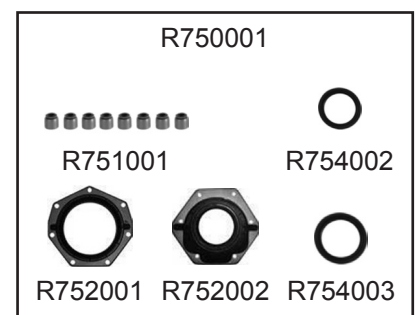
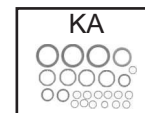
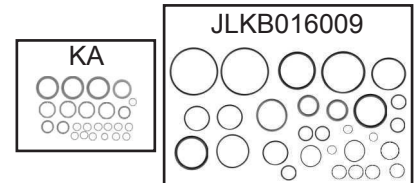

Juntalima
Indústria e Comércio de Auto Peças Ltda

CONHEÇA NOSSA LINHA DE RETENTORES



Fiat



Juntalima

Motor/Engine 3.0 16V F1CE0481D

Códigos jogos de juntas
Code set gaskets

Modelo / Model	Cm ³	De	Até
Ducato JTD	2999	2006	

Completo sem cabeçote 40807SC	Full set without cyl. head gasket 40807SC
Completo s/cabeçote c/retentores 40807SCR	Full set w/o cyl. head gasket with seals 40807SCR
Kit retificação sem cabeçote 40807KSC	Retification kit without head gasket 40807KSC
Kit s/cabeçote c/retentores 40807KSCR	Head set w/o head gasket with seals 40807KSCR

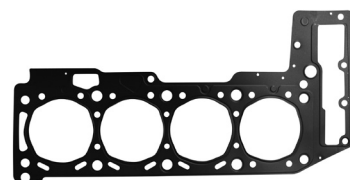

JL40807-1/ JL40807-2/ JL40807-3
JL40807MP

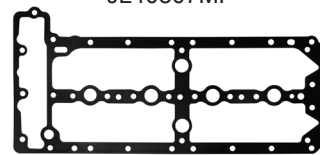

JL40036



JL40032



JL40822



JL40016



JL40034

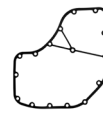

JL40840



JL40848



JL40820



JL40841



JL40842



JL40843



JL40844



JL40845



JL40846



JL40847



JL40849



JL40850



JL40851



JL40825A

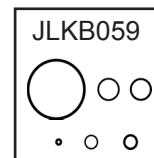

JLKB059

Código/Code	N° Original	Aplicação / application	MP	C	K	M
40807MLS-1	0209FJ	Cabeçote / cylinder head gasket 1,2mm	MLS			
40807MLS-2	0209FJ	Cabeçote / cylinder head gasket 1,3mm	MLS			
40807MLS-3	0209FJ	Cabeçote / cylinder head gasket 1,4mm	MLS			
40807MP	0209FJ	Cabeçote / cylinder head gasket	MP			
40036	0249F7	Tampa de válvulas / rocker cover gasket	MLS	1	1	1
40032	03448T7	Coletor de admissão / intake manifold	MLS	1	1	1
40822	0349L8	Coletor de escapamento / exhaust manifold	PAK	1	1	1
40016	30459	Carter	BO	1		1
40034	170938	Tubo de escapamento /	CNAC	2	2	2
40840		Tampa da distribuição	MLS	1		1
40848		Radiador do óleo	MLS	1		1
40820		Guarnição	PAK	1		1
40841		Bomba d'água	MLS	1		1
40842		Filtro da bomba de óleo	MLS	1		1
40843		Guarnição	MLS	1	1	1
40844		Tubo do cano do óleo	CNAC	1		1
40845		Radiador do óleo	MLS	1		1
40846		Guarnição	MLS	1	1	1
40847		Bomba de óleo	MLS	1		1
40849		Guarnição	BO	1		1
40850		Carcaça termostato	MLS	1	1	1
40851		Traseira do cabeçote	PAK	1	1	1
40825A		Turbina	CNAC	1		1
KB059		Kit de borrachas / Kit rubbers	KB	1		1
R750002		Kit de retentores para motor completo				
R751002		Retentores de haste de válvulas 5,5x10,5x19,5	BO	16	16	16
R754004		Retentor dianteiro do virabrequim 50x70x11	BO	1		1
R753002		Retentor traseiro do virabrequim 90x120x13	BO	1		1





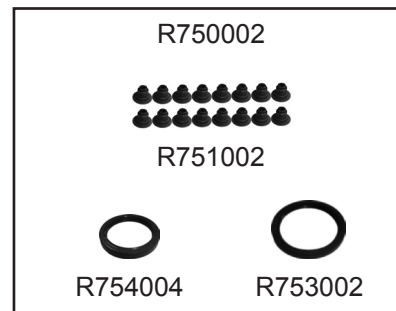
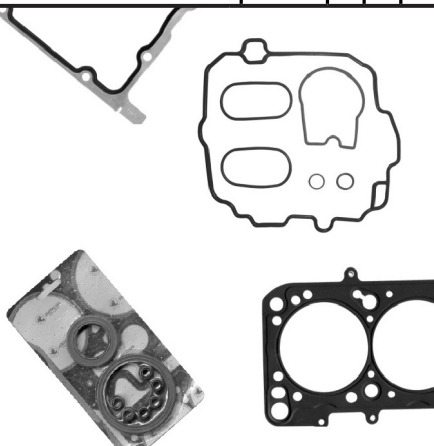

Juntalima
Indústria e Comércio de Auto Peças Ltda



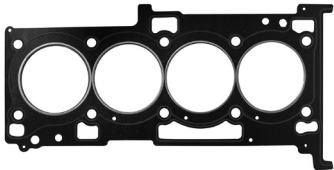
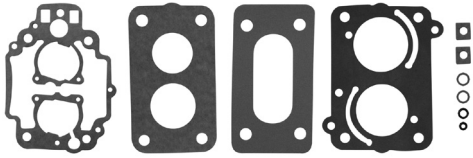
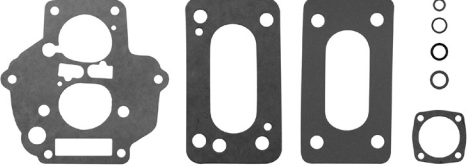
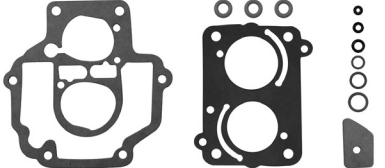

- Juntas mls
- Juntas Metal-Elastômeto
- Juntas em Borracha
- Cortiças
- Retentores



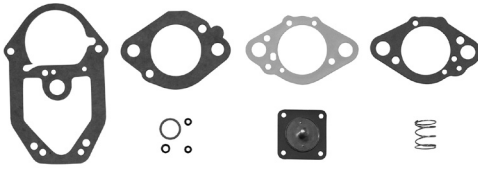
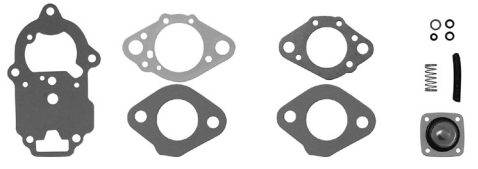
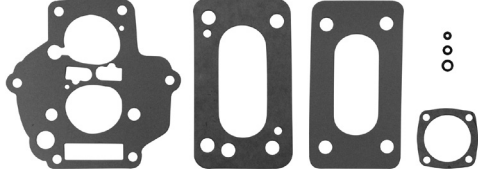
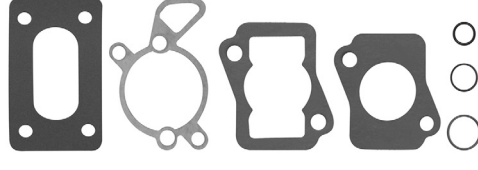

Junta	Aplicação	Veículo / Motor
 <p>JL40808</p>	Junta do cabeçote	Fiat Freemont/ Dodge Journey 2.5 16V ED3 VVT
 <p>JL40570</p>	Jogo de juntas para carburador	Weber TLDF
	Jogo de juntas para carburador	Tempra 2.0 8V/Uno
	Jogo de juntas para carburador	Uno Mille eletrônico com manta
 <p>JL40251B</p>	Jogo de juntas para carburador	Uno Mille eletrônico/Prêmio 1.5 1985 Weber
 <p>JL40350</p>	Jogo de juntas para carburador	147 - 1300 Solex
 <p>JL40360</p>	Jogo de juntas para carburador	1050-1300 Weber duplo
 <p>JL40370</p>	Jogo de juntas para carburador	1050-1300 Weber até 1982

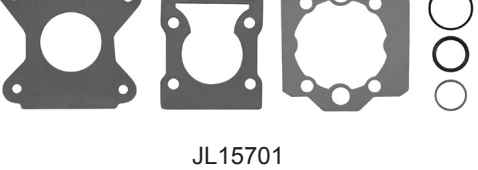

Junta	Aplicação	Veículo / Motor
 <p>JL40350K</p>	<p>Kit de reparos para carburador</p>	<p>1050-1300 Simples Gasolina Solex 70.007</p>
 <p>JL40570</p>	<p>Kit de reparos para carburador</p>	<p>Mille/Chevrolet Chevette Junior Simples Álcool/Gasonila</p>
 <p>JL40560</p>	<p>Jogo de juntas para carburador</p>	<p>Weber duplo</p>
 <p>JL15712</p>	<p>Jogo de juntas para I.E.</p>	<p>Mille/Uno SX 1997 Singlepoint</p>
 <p>JL15700</p>	<p>Jogo de juntas para I.E.</p>	<p>Mille/Elba/Prêmio Singlepoint (viton)</p>
 <p>JL15701</p>	<p>Jogo de juntas para I.E.</p>	<p>Tipo 1.C Calço imp. Singlepoint (Anel viton)</p>
 <p>JL15702</p>	<p>Jogo de juntas para I.E.</p>	<p>Tipo 2.0 16V MPI Multipoint</p>
 <p>JL15703</p>	<p>Jogo de juntas para I.E.</p>	<p>Tempra 2.0 16V Multipoint (Anel viton)</p>

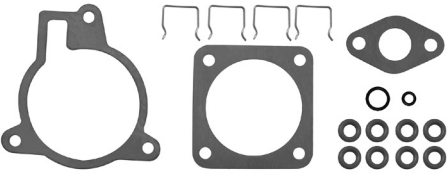
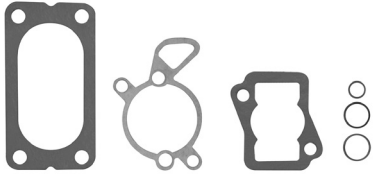
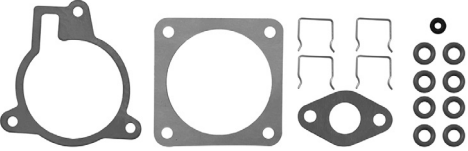
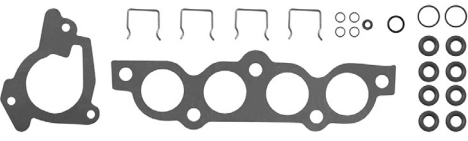
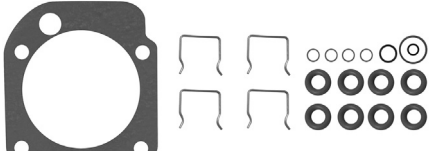
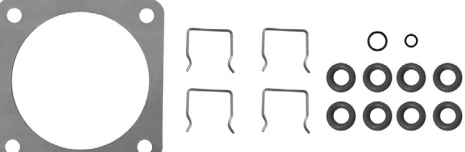
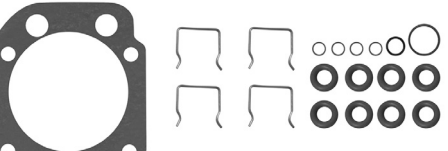
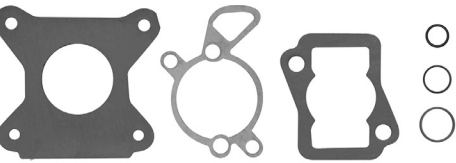

Junta	Aplicação	Veículo / Motor
 <p>JL15704</p>	Jogo de juntas para I.E.	Tempra 2.0 16V Multipoint (com 8 aneis viton)
 <p>JL15705</p>	Jogo de juntas para I.E.	Tempra 2.0 16V Singlepoint S.P.I. (Anel viton)
 <p>JL15706</p>	Jogo de juntas para I.E.	Tempra 2.0 16V MPI Multipoint
 <p>JL15707</p>	Jogo de juntas para I.E.	Palio 1.0/1.5 8V MPI Multipoint (anel viton)
 <p>JL15708</p>	Jogo de juntas para I.E.	Palio 16V Multipoint
 <p>JL15709</p>	Jogo de juntas para I.E.	Tipo 1.6 nacional Multipoint
 <p>JL15710</p>	Jogo de juntas para I.E.	Uno/Elba/Prêmio 1.5/1.6 Multipoint
 <p>JL15711</p>	Jogo de juntas para I.E.	Palio/Siena 1.6 Singlepoint (Anel viton)

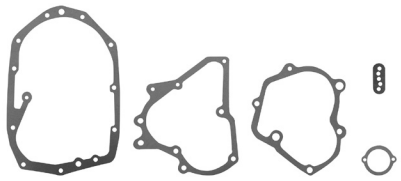
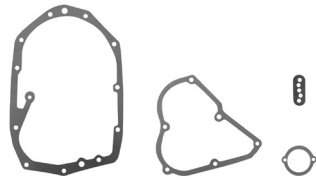
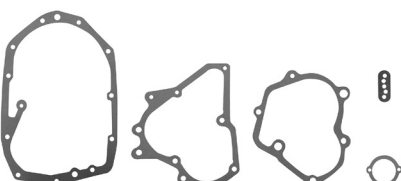

Junta	Aplicação	Veículo / Motor
 <p>JL40391</p>	Jogo de juntas para câmbio	Fiat todos 5 marchas
 <p>JL40380</p>	Jogo de juntas para câmbio	147 (todos)
 <p>JL40390</p>	Jogo de juntas para câmbio	Fiat moderno 4 marchas