



FORD

CATÁLOGO LINHA LEVE
EDIÇÃO 15 ANO 2017



Motor/Engine 1.0 8V CHT / AE

Códigos jogos de juntas
Code set gaskets

Modelo / Model	Cm³	De	Até
Escort Hobby	997	1993	1996
Gol	997	1993	

Completo com retentores
11806CR
Completo sem retentores
11806C
Kit retificação com retentores
11806KR
Kit retificação sem retentores
11806K

Full set with oil seals
11806CR
Full set without oil seals
11806C
Head set with oil seals
11806KR
Head set without oil seals
11806K

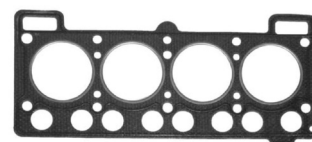

JL11801G



JL11226



JL11821

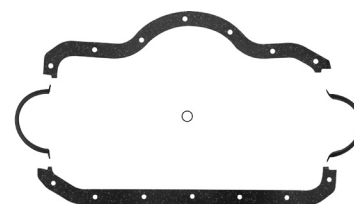

JL11816

Código/Code	Nº Original	Aplicação / application	MP	C	K	M
11801G	84AU6051A	Cabeçote / cylinder head gasket	PAK	1	1	
11226	64.293	Tampa de válvulas / rocker cover gasket	BO	1	1	
11821	84AU944A	Coletor de admissão / intake manifold	PAK	1	1	
11816	84SU6781A	Cárter / oil pan	CB	1		
11822F	84AU9451A	Saída do escapamento / exhaust pipe	CNAC	1	1	
11228	BD3M6020A	Tampa da distribuição / timing cover	NA	1		
11832	84AU8507A	Bomba d'água / water pump	GV	1		
11830	84AU6W021A	Tampa traseira cabeçote	GV	1	1	
11831	84AU8513A	Bomba d'água / water pump	GV	1	1	
11835	86AU8507AA	Suporte bomba d'água / water pump	GV	1	1	
11636	BD9M6659A	Bomba de óleo / oil pump ao bloco	GV	1		
11272	BD5M941A	Bomba de gasolina / gasoline pump	NA	2		
11833	6.071.557	Base do distribuidor	NA	1		
11625C	BD9M6C055A	Camisas	LT	1		
46247	F70Z6675AA	Anel do bujão 14x20	AL	1		
11240B	65.583	Jogo de borracha com caneca	CHBO	1	1	
R930005		Kit de retentores para motor completo				
R921003	88WM6571BB	Retentores de haste de válvulas 8x10,8x10,3	VI	8	8	
R933003	78MU6701B	Retentor traseiro do virabrequim 82x105x12	SI	1		
R934004	BD3M6700A	Retentor dianteiro do virabrequim 35x50x7	SI	1		



JL11822F JL11228 JL11832



JL11835 JL11636 JL11830



JL11831 JL11272 JL11625C

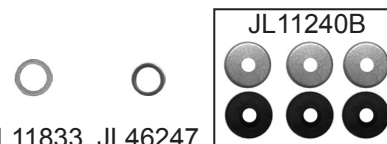

JL11833 JL46247

Itens Relacionados

Juntas para Injeção eletrônica

Juntas para Injeção eletrônica

Juntas para Carburador

Kit de tampa de válvulas



JL15902
Jogo juntas I.E.
Gol 1000 plus CFI
Motor AE



JL15906
Jogo juntas I.E.
Golf 1.8/gol 1.0
Motor AP multipoint



JL11860
Jogo de juntas carburador
Escort CHT 86
Solex duplo

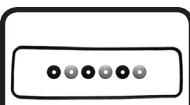

JL11226KTV
Kit de tampa e vedador de válvulas
Escort/ Del Rey CHT - 7 peças



Em breve novidades

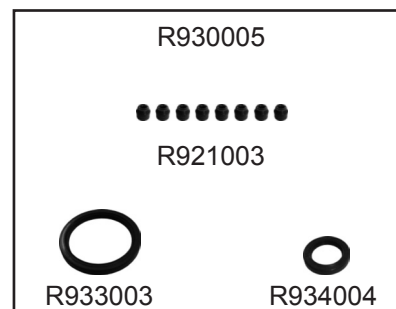

Ford



Juntalima

Motor/Engine 1.0 12V M1DA TiVCT

Códigos jogos de juntas
Code set gaskets

Modelo / Model	Cm³	De	Até	Completo com retentores 11809CR	Full set with oil seals 11809CR
Ka	997	2014		Completo sem retentores 11809C	Full set without oil seals 11809C
Ka+	997	2014		Completo MLS com retentores 11809CMR	Full set MLS with oil seals 11809CMR
				Completo MLS sem retentores 11809CM	Full set MLS without oil seals 11809CM
				Kit retificação com retentores 11809KR	Head set with oil seals 11809KR
				Kit retificação sem retentores 11809K	Head set without oil seals 11809K
				Kit retificação MLS com retentores 11809KMR	MLS Head set with oil seals 11809KMR
				Kit retificação MLS sem retentores 11809KM	MLS Head set without oil seals 11809KM

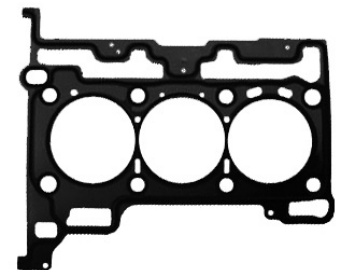

JL11809

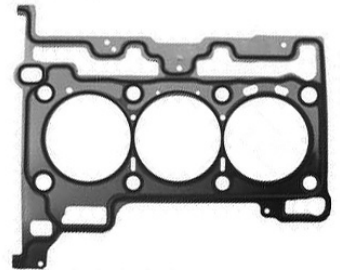

JL11809MLS

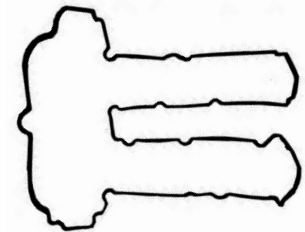

JL11727



JL11022



JL11122



JL11004



JL11005



JL11006



JL11008



JL11009



JL11010

Código/Code	N° Original	Aplicação / application	MP	C	K	M
11809	6051B	Cabeçote / cylinder head gasket	PAK	1	1	
11809MLS	6051B	Cabeçote / cylinder head gasket	MLS			1
11727	6K260EA	Tampa de válvulas / rocker cover gasket	BO	1	1	1
11022	9424A	Coletor de admissão / intake manifold	BO	3	3	3
11122	9L467BA	Coletor de escapamento / exhaust manifold	CNAC	1	1	1
11004		Catalizador	CNAC	1	1	1
11005	8255A	Carcaça válvula termostática	BO	1	1	1
11006	2A572A	Bomba de vácuo	NA	1		1
11008		Guarnição	BO	1		1
11009		Anel de vedação	BO	1		1
11010		Anel de vedação	BO	1		1
R930010		Kit de retentores para motor completo	KT			
R931009		Retentores de haste de válvulas 4,25x9x17	VI	12	12	12
R932005		Retentor do comando de válvulas 35,8x48x7	SI	2	2	2
R932005	6335A	Retentor traseiro do virabrequim (flange)	PTFE	1		1
R754003		Retentor dianteiro do virabrequim 55x70x8	SI	1		1



Juntalima
Indústria e Comércio de Auto Peças Ltda

**REFERÊNCIA NACIONAL
EM JUNTAS MLS**

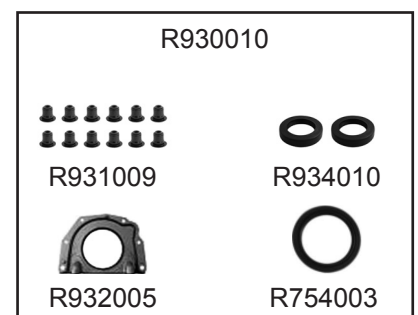

NOVO

Ford



Juntalima

Motor/Engine 1.0 8V Endura (HCS) OHV

Códigos jogos de juntas
Code set gaskets

Modelo / Model	Cm³	De	Até	Completo com retentores 11403CR	Full set with oil seals 11403CR
Fiesta	999	1996	1999	Completo sem retentores 11403C	Full set without oil seals 11403C
Ka	999	1997	1999	Kit retificação com retentores 11403KR Kit retificação sem retentores 11403K Completo premium com retentores 11403CPR Completo premium sem retentores 11403CP	Head set with oil seals 11403KR Head set without oil seals 11403K Premium full set with oil seals 11403CPR Premium full set without oil seals 11403CP



JL11401G



JL11426



JL11421F



JL11721



JL11722

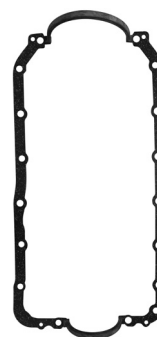

JL11416



JL11416AL

Código/Code	N° Original	Aplicação / application	MP	C	K	P
11401G	96BM6051A1A	Cabeçote / cylinder head gasket	PAK	1	1	1
11426	96BM6584A1A	Tampa de válvulas / rocker cover gasket	CB	1	1	1
11421F	95BM9448AC	Coletor de escapamento	CNAC	4	4	4
11721	89BM944AB	Coletor de escapamento / exhaust manifold	PAK	1	1	1
11722	89BM944AA	Coletore de admissão / intake manifold	NA	1	1	1
11416	056103690A	Cárter / oil pan	CB	1		
11416AL		Cárter de alumínio com borracha	BOAL			1
11751	92FB9451AA	Saida do escapamento	CNAC	1	1	1
11651	95FB9451BA	Saida do escapamento	CNAC	1	1	1
11428	89BM6020AA	Tampa da distribuição / timing cover	CB	1	1	1
11429	89BM6344BA	Arvore de manivelas traseira	NA	1	1	1
11338	96BM6659AA	Bomba de gasolina / gasoline pump	NA	1	1	1
11730	89BM8507AA	Bomba d'água / water pump	NA	1	1	1
11311	84BF8255AA	Junta da válvula termostática	NA	1	1	1
11235	95BF9P8AB	Junta do corpo do tubo de admissão de ar	BO	1		1
11452		Borracha anel oito (5020)	BO	2	2	2
46247		Anel do bujão 14x20	AL	1	1	1
R930004		Kit de retentores para motor completo				
R931005	88WM6571BB	Retentores de haste de válvulas 7x11x10,2	VI	8	8	8
R933002	8BM6701A6A	Retentor traseiro do virabrequim 79,38x95,25x11	SI	1		1
R934006	05167BRAGEF	Retentor dianteiro do virabrequim 36,6x52,35x8,3	SI	1		1



JL11751

JL11651

JL11428



JL11429



JL11338



JL11730



JL11311



JL11235



JL11452



JL46247

Itens Relacionados

Juntas para
Cárter

JL15802
Jogo de juntas I.E.
Fiesta 1.3
Singlepoint (anel
viton)

Em breve
novidades

Em breve
novidades

Em breve
novidades

Em breve
novidades

R930004

R931005

R933002

R934006

Ford



Juntalima

Motor/Engine 1.0 8V Endura Rocam
Supercharger

Códigos jogos de juntas
Code set gaskets

Modelo / Model Cm³ De Até

Fiesta Supercharger 999 2003
Ecosport 999 2003

Completo com retentores 11808CR	Full set with oil seals 11808CR
Completo sem retentores 11808C	Full set without oil seals 11808C
Completo MLS com retentores 11808CMR	Full set MLS with oil seals 11808CMR
Completo MLS sem retentores 11808CM	Full set MLS without oil seals 11808CM
Kit retificação com retentores 11808KR	Head set with oil seals 11808KR
Kit retificação sem retentores 11808K	Head set without oil seals 11808K
Kit retificação MLS com retentores 11808KMR	MLS Head set with oil seals 11808KMR
Kit retificação MLS sem retentores 11808KM	MLS Head set without oil seals 11808KM

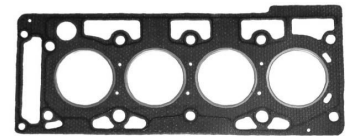

JL11101G



JL11101MLS

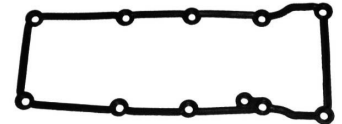

JL11626



JL11523



JL11622

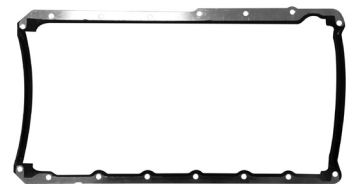

JL11216AL



JL11121

JL11331

JL11843



JL11333



JL11452

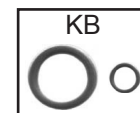

KB

Código/Code	N° Original	Aplicação / application	MP	C	K	M
11101G	XS6E6051AC	Cabeçote / cylinder head gasket	PAK	1	1	
11101MLS	XS6E6051AC	Cabeçote / cylinder head gasket	MLS			1
11626	XS6E6584AB	Tampa de válvulas / rocker cover gasket	BO	1	1	1
11523		Coletor de escapamento / exhaust manifold	MLS	1	1	1
11622		Coletor de admissão / intake manifold	SI	2	2	2
11216AL	XS6E6710A2B	Cárter / oil pan	BOAL	1		1
11121	XS619451DC	Saída do escapamento / exhaust pipe	CNAC	1	1	1
11331	XS6E6659A2B	Tampa da distribuição / timing cover	NA	1	1	1
11843	XS6E8255BB	Carcaça termostática	SI	1	1	1
11333	XS656621/AD	Cabeçote do Filtro de óleo / oil filter	NA	1	1	1
11452		Borracha anel oito (5020)	BO	1	1	1
KB		Kit de borrachas / kit rubbers	KB	1	1	1
R930001		Kit de retentor para motor completo				
R931001	XS6E57AB	Retentores de haste de válvulas 6x11x17,8	VI	8	8	8
R932001	XS6E6K301BE	Retentor traseiro do virabrequim (flange)	VI	1		1
R934001	XS6E6700BA	Retentor dianteiro do virabrequim 40x62x8	SI	1		1

Itens Relacionados

Juntas Diversas

Juntas Diversas

JL11335
Junta do corpo do tubo da admissão de ar - Silicone XS6E9P848AA

JL11331MLS
Tampa distribuição Bomba d'água e óleo Zetec rocam 1.0/1.6 MLS

Em breve novidades

Em breve novidades

Em breve novidades

R930001

R931001

R932001

R934001

Ford



Juntalima

Motor/Engine 1.0 8V Zetec Rocam

Códigos jogos de juntas
Code set gaskets

Modelo / Model	Cm²	De	Até	Completo com retentores 11907CR	Full set with oil seals 11907CR
Fiesta	999	1999		Completo sem retentores 11907C	Full set without oil seals 11907C
Ka	999	1999		Completo MLS com retentores 11907CMR	Full set MLS with oil seals 11907CMR
				Completo MLS sem retentores 11907CM	Full set MLS without oil seals 11907CM
				Kit retificação com retentores 11907KR	Head set with oil seals 11907KR
				Kit retificação sem retentores 11907K	Head set without oil seals 11907K
				Kit retificação MLS com retentores 11907KMR	MLS Head set with oil seals 11907KMR
				Kit retificação MLS sem retentores 11907KM	MLS Head set without oil seals 11907KM

Código/Code	Nº Original	Aplicação / application	MP	C	K	M
11101G	XS6E6051AC	Cabeçote / cylinder head gasket	PAK	1	1	
11101MLS	XS6E6051AC	Cabeçote / cylinder head gasket	MLS		1	1
11626	XS6E6584AB	Tampa de válvulas / rocker cover gasket	BO	1	1	1
11431MLS	XS6E9448AC	Coletor de escapamento / exhaust manifold	MLS	1	1	1
11520	XS6E9441BA	Coletor de admissão / intake manifold	SI	2	2	2
11216AL	XS6E6710A2B	Cárter / oil pan	BOAL	1		1
11121	XS619451DC	Saída do escapamento / exhaust pipe	CNAC	1	1	1
11331	XS6E6659A2B	Tampa da distribuição / timing cover	NA	1	1	1
11843	XS6E8255B	Carcaça termostática	SI	1	1	1
11333	XS656621/AD	Cabeçote do Filtro de óleo / oil filter	NA	1	1	1
11453		Borracha anel oito (5022)	BO	1	1	1
KB		Kit de borrachas / kit rubbers	KB	1	1	1
R930001		Kit de retentores para motor completo				
R931001	XS6E6571AB	Retentores de haste de válvulas 6x11x17,8	VI	8	8	8
R932001	XS6E6K301BE	Retentor traseiro do virabrequim (flange)	VI	1		1
R934001	XS6E6700BA	Retentor dianteiro do virabrequim 40x62x8	SI	1		1

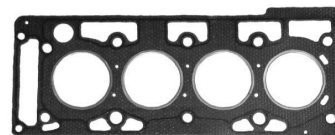

JL11101G



JL11101MLS

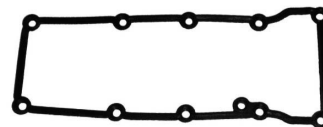

JL11626



JL11431MLS



JL11520

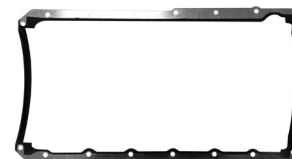

JL11216AL



JL11121

JL11331



JL11843



JL11333



JL11453



Itens Relacionados

Juntas Diversas

Juntas Diversas

JL11335
Junta do corpo do tubo da admissão de ar - Silicone XS6E9P848AA

JL11331MLS
Tampa distribuição Bomba d'água e óleo Zetec rocam 1.0/1.6 MLS

Em breve novidades

Em breve novidades

Em breve novidades

R930001

R931001

R932001

R934001

Ford



Juntalima

Motor/Engine 1.3 8V Endura OHV (HCS)

Códigos jogos de juntas
Code set gaskets

Modelo / Model	Cm³	De	Até	Completo com retentores 11503CR	Full set with oil seals 11503CR
Escort	1299	1995		Completo sem retentores 11503C	Full set without oil seals 11503C
Fiesta	1299	1995		Kit retificação com retentores 11503KR	Head set with oil seals 11503KR
Ka	1299	1995		Kit retificação sem retentores 11503K	Head set without oil seals 11503K
Courier	1299	1996		Completo premium com retentores 11503CPR	Premium full set with oil seals 11503CPR
				Completo premium sem retentores 11503CP	Premium full set without oil seals 11503CP

Código	N° Original	Aplicação / application	MP	C	K	M	P
11501G	96BM6051A2A	Cabeçote / cylinder head gasket	PAK	1	1		1
11426	96BM6584A1A	Tampa de válvulas / rocker cover gasket	CB	1	1	1	1
11421F	95BM9448AC	Coletor de Escapamento / exhaust manifold	CNAC	4	4	4	4
11721	89BM9441AB	Coletor de escapamento / exhaust manifold	PAK	1	1	1	1
11722	89BM9441AA	Coletor de admissão / intake manifold	NA	1	1	1	1
11416	056103690A	Cárter / oil pan	CB	1		1	
11416AL		Cárter de alumínio com borracha	BOAL				1
11751	92FB9451AA	Saída do escapamento / exhaust pipe	CNAC	1	1	1	1
11428	89BM6020AA	Tampa da distribuição / timing cover	CB	1			1
11429	89BM6344BA	Arvore de manivelas traseira	NA	1		1	1
11338	1.651.769	Bomba de gasolina / gasoline pump	NA	1	1	1	1
11730	89BM8507AA	Válvula termostática / thermostatic valve	NA	1	1	1	1
11311	84BF8255AA	Bomba d'água / water pump	NA	1	1	1	1
11235	95BF9P848AB	Corpo tubo admissão de ar	BO	1		1	1
11452		Borracha anel oito (5020)	BO	2	2	1	2
46247	F70Z6675AA	Anel do bujão 14x20	AL	1			1
11651		Saída do escapamento	CNAC	1	1	1	1
R930004		Kit de retentores para motor completo					
R931005	88WVM6571BB	Retentores de haste de válvulas 7x11x10,2	VI	8	8	8	8
R933002	8BM6701A6A	Retentor traseiro do virabrequim 79,38x95,25x11	SI	1		1	1
R934006	05167BRAGEF	Retentor dianteiro do virabrequim 36,6x52,35x8,3	SI	1		1	1

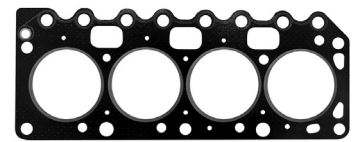

JL11501G



JL11426



JL11421F



JL11721



JL11722

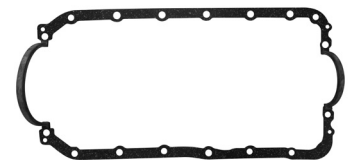

JL11416

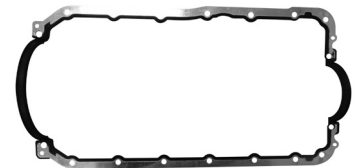

JL11416AL



JL11751

JL11428

JL11429



JL11338



JL11730



JL11311



JL11235



JL11452



JL46247



JL11651

R930004



R931005



R933002



R934006

Itens Relacionados

Juntas para Injeção Eletrônica



JL15802
Jg de jtas I.E. Fiesta 1.3 Singlepoint (anel viton)

Em breve novidades

Em breve novidades

Em breve novidades

Em breve novidades

Ford



Juntalima

Motor/Engine 1.3 Corcel I

Códigos jogos de juntas
Code set gaskets

Modelo / Model	Cm³	De	Até
Corcel I	1300	1971	1977

Completo com retentores
11220CR
Completo sem retentores
11220C
Kit retificação sem retentores
11220K

Full set with oil seals
11220CR
Full set without oil seals
11220C
Head set without oil seals
11220K

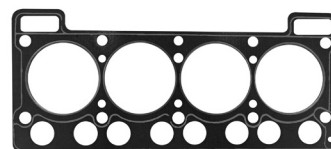

JL11201G



JL11226



JL11221

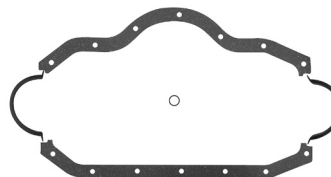

JL11219



JL11237F



JL11228



JL11229



JL11230



JL11231



JL11236



JL11636



JL11234
(x2)



JL11435(x2)



JL11248



JL11247(x2)



JL11203(x2)



JL11227



JL11833



JL11225PP

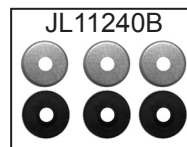

JL11240B

Código/Code	N° Original	Aplicação / application	MP	C	K	M
11201G	BNO22-BAP	Cabeçote / cylinder head gasket	PAK	1	1	
11226	64.293	Tampa de válvulas / rocker cover gasket	BO	1	1	
11221	BD9M-9448-A	Coletor de escapamento / exhaust manifold	PAK	1	1	
11219	85.187	Cárter / oil pan	CB	1		
11237F	57.101	Sáida do escapamento	CNAC	1	1	
11228	BD3N-6020-A	Tampa da distribuição / timing cover	CB	1		
11229	48.437	Bomba d'água / water pump (ext)	GV	1		
11230	48.496	Bomba traseira do cabeçote	GV	1	1	
11231	48.470	Bomba d'água / water pump (int)	GV	1	1	
11236	65.689	Bomba de óleo / oil pump	GV	1		
11636	BD5M-6659-A	Bomba de óleo / oil pump	GV	1		
11234	BD5M-9417-A	Bomba de gasolina / gasoline pump	NA	2		
11435	2101-1005155	Carburador / carburetor	NA	2		
11248	48.296	Bomba de gasolina / gasoline pump	NA	1		
11247	BD2M-9447-A	Base do carburador / Base carburetor	NA	2		
11203		Base do carburador / Base carburetor	NA	2		
11227	48.069	Flange do Filtro de óleo / oil filter	NA	1		
11833	6.071.557	Base do distribuidor	NA	1		
11225PP	48.905	Camisa	PP	8		
11240B	65.583	Jogo de vedador TV borracha e chapa	CHBO	6	6	
R930008		Kit de retentores para motor completo				
R933003	78MU6701B	Retentor traseiro do virabrequim 82x105x12	SI	1		
R934004	BD3M6700A	Retentor dianteiro do virabrequim 35x50x7	SI	1		

Itens Relacionados

Juntas para Carburador



JL11162
Jg. juntas carburador Corcel 1.4/1.6 Weber

Juntas para Carburador

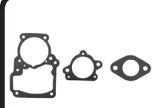

JL11162K
Kit carb. Corcel II simples gasolina DFV weber

Juntas para Câmbio



JL11191
Jg de juntas câmbio Corcel todos 4 marchas

Juntas para Câmbio

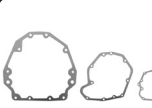

JL11481
Jogo junta câmbio Corcel II/Del Rey 5 marchas

Kit de tampa de válvulas

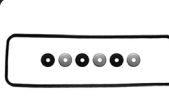

JL11226KTV
Kit de tampa e vedador de válvulas Corcel/ Escort/ Del Rey CHT - 7 peças

R930008



R933003



R934004

Ford



Juntalima

Motor/Engine 1.4 16V Zetec SE

Códigos jogos de juntas
Code set gaskets

Modelo / Model	Cm³	De	Até	Completo com retentores 11803CR	Full set with oil seals 11803CR
Fiesta	1388	1996		Completo sem retentores 11803C	Full set without oil seals 11803C
Courier	1388	1996		Completo MLS com retentores 11803CMR	Full set MLS with oil seals 11803CMR
Puma	1388	1996		Completo MLS sem retentores 11803CM	Full set MLS without oil seals 11803CM
				Kit retificação com retentores 11803KR	Head set with oil seals 11803KR
				Kit retificação sem retentores 11803K	Head set without oil seals 11803K
				Kit retificação MLS com retentores 11803KMR	MLS Head set with oil seals 11803KMR
				Kit retificação MLS sem retentores 11803KM	MLS Head set without oil seals 11803KM



JL11301G



JL11301MLS



JL11826



JL11521F



JL11420

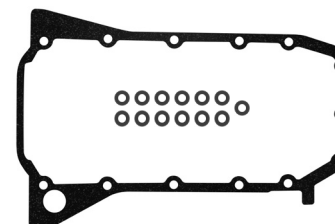

JL11516B



JL11733

JL11836

JL11405



JL25022

JL10004

Código/Code	Nº Original	Aplicação / application	MP	C	K	M
11301G	97MM6051BC	Cabeçote / cylinder head gasket	PAK	1	1	
11301MLS	97MM6051BC	Cabeçote / cylinder head gasket	MLS		1	1
11826	98MM6M293BE	Tampa de válvulas / rocker cover gasket	BO	1	1	1
11521F	96MM9441AD	Coletor de escapamento / exhaust manifold	CNAC	1	1	1
11420	96MM9441AD	Coletor de admissão / intake manifold	SI	2	2	2
11516B	96MM6710AD	Cárter com limitador	CB	1		1
11733	96MM6659AD	Tampa da distribuição / timing cover	NA	1		1
11836	96MM8507CC	Bomba d'água / water pump	NA	1	1	1
11405	96MM8587AC	Tube da saída da bomba d'água	NA	1		1
25022		Arruela 16x22x1.5mm	AL	1		1
10004		Anel de borracha termostato	BO	1		1
R930002		Kit de retentores para motor completo				
R931002	96MM6571BE	Retentores de haste de válvulas 6x11x17,8	VI	16	16	16
R934003	96MM6K292	Retentor do comando de válvulas 38x52x6	SI	2	2	2
R932002	1143317	Retentor traseiro do virabrequim (flange)	PTFE	1		1
R934002	1004457	Retentor dianteiro do virabrequim 33x47x5	SI	1		1

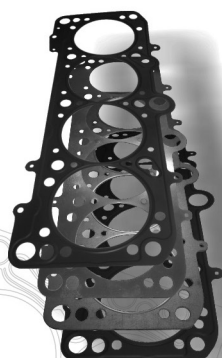

Juntalima
Indústria e Comércio de Auto Peças Ltda

**REFERÊNCIA NACIONAL
EM JUNTAS MLS**

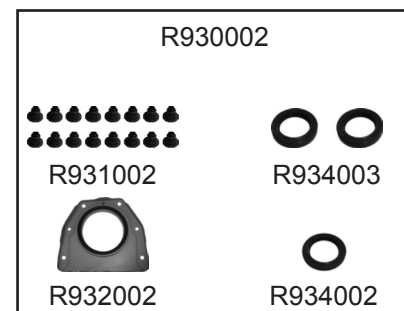

Ford



Juntalima

Motor/Engine 1.4 Corcel II

Códigos jogos de juntas
Code set gaskets

Modelo / Model	Cm³	De	Até
Corcel II	1400	1978	1983
Belina	1400	1978	1983
Del Rey	1400	1978	1983

Completo com retentores
11620CR
Completo sem retentores
11620C
Kit retificação com retentores
11620KR
Kit retificação sem retentores
11620K

Full set with oil seals
11620CR
Full set without oil seals
11620C
Head set with oil seals
11620KR
Head set without oil seals
11620K

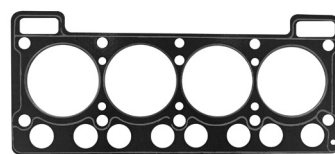

JL11601AG



JL11226



JL11621

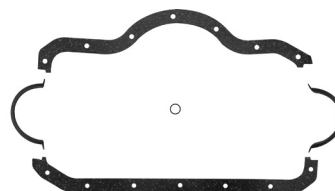

JL11816



JL11237F



JL11228



JL11229



JL11230



JL11231



JL11236



JL11636



JL11234
(x2)



JL11233
(x2)



JL11248



JL11272
(x2)



JL11247
(x2)



F910(x2)



JL11833



JL11632B



JL11227



JL11625C
(x4)

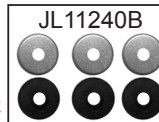

JL11240B

Código/Code	N° Original	Aplicação / application	MP	C	K	M
11601AG	BD9M-6051-A	Cabeçote / cylinder head gasket	PAK	1	1	
11226	64.293	Tampa de válvulas / rocker cover gasket	BO	1	1	
11621	BD9M-9448-A	Coletor de escapamento / exhaust manifold	PAK	1	1	
11816	85.958	Cárter / oil pan	CB	1		
11237F	57.101	Saída do escapamento / exhaust pipe	CNAC	1	1	
11228	BD3M-6020-A	Tampa da distribuição / timing cover	CB	1		
11229	48.437	Bomba d'água / water pump (ext)	GV	1		
11230	48.496	Bomba traseira do cabeçote	GV	1	1	
11231	48.470	Bomba d'água / water pump (ext)	GV	1	1	
11236	65.689	Bomba de óleo bloco do motor	GV	1		
11636	BD9M-6659-A	Bomba de óleo do bloco do motor	GV	1		
11234	BD5M-9414-A	Bomba de gasolina / gasoline pump	NA	2		
11233		Carburador / carburetor	NA	2		
11248	48.296	Bomba de gasolina / gasoline pump	NA	1		
11272	BD5M-9417-A	Bomba de gasolina / gasoline pump	NA	2		
11247	BD2M-9447-A	Base do carburador / Base carburetor	NA	2		
F910		Base do carburador / Base carburetor	NA	2		
11227	48.069	Flange do Filtro de óleo / oil filter	NA	1		
11833	6.071.557	Base do distribuidor	NA	1		
11625C	BD9M6C055A	Camisas latão 0,10	LT	4		
11632B		Borracha	BO	1		
11240B	65.583	Jogo de vedador de borracha e chapa	CHBO	1		
R930008		Kit de retentores para motor completo				
R933003	78MU6701B	Retentor traseiro do virabrequim 82x105x12	SI	1		
R934004	BD3M6700A	Retentor dianteiro do virabrequim 35x50x7	SI	1		

Itens Relacionados

Juntas para Carburador



JL11162
Jg juntas carburador Corcel 1.4/1.6 Weber

Juntas para Carburador



JL11162K
Kit carb. weber Corcel II DFV-Simples gasolina

Juntas para Câmbio



JL11191
Jg de juntas câmbio Corcel todos 4 marchas

Juntas para Câmbio

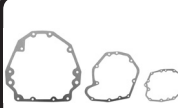

JL11481
Jg de juntas câmbio Corcel II/Dey Rey 5 marchas

Kit de tampa de válvulas

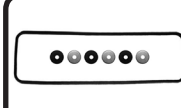

JL11226KTV
Kit de tampa e vedador de válvulas Corcel/ Escort/ Del Rey CHT - 7 peças

JL11227

JL11625C
(x4)

JL11240B

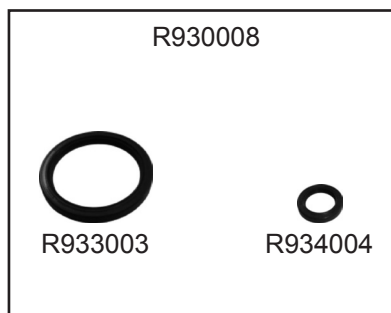

R933003

R934004

R930008



Motor/Engine 1.6 8V CHT/AE

Códigos jogos de juntas
Code set gaskets

Modelo / Model	Cm³	De	Até	Completo com retentores 11807CR	Full set with oil seals 11807CR
Escort	1555	1980		Completo sem retentores 11807C	Full set without oil seals 11807C
Corcel II	1555	1983		Kit retificação com retentores 11807KR	Head set with oil seals 11807KR
Belina	1555	1983		Kit retificação sem retentores 11807K	Head set without oil seals 11807K
Del Rey	1555	1983			
Verona	1555	1989			
Gol	1555	1989			
Parati	1555	1989			
Saveiro	1555	1989			
Voyage	1555	1989			

Código/Code	Nº Original	Aplicação / application	MP	C	K	M
11802AG	84AU6051B	Cabeçote / cylinder head gasket	PAK	1	1	
11226	64.293	Tampa de válvulas / rocker cover gasket	BO	1	1	
11821	84AU94448A	Coeltor de escapamento / exhaust manifold	PAK	1	1	
11816	84SU6781A	Cárter / oil pan	CB	1		
11822F	84AU9451A	Saída do escapamento / exhaust pipe	CNAC	1	1	
11228	BD3M6020A	Tampa da distribuição / timing cover	CB	1		
11832	84AU8507A	Bomba d'água / water pump	GV	1		
11830	84AU6W021A	Tampa traseira do cabeçote	GV	1	1	
11831	84AU8513A	Bomba d'água / water pump	GV	1	1	
11835	86AU8507AA	Suporte bomba d'água / water pump	GV	1	1	
11236	65.689	Bomba óleo do bloco do motor	GV	1		
11636	DB9M6659A	Bomba óleo do bloco do motor	GV	1		
11234	8D5M9417A	Bomba de gasolina / gasoline pump	NA	2		
11272	BD5M9417A	Bomba de gasolina / gasoline pump	NA	2		
11248		Bomba de gasolina / gasoline pump	NA	1		
11247		Base do carburador / Base carburetor	NA	2		
11833	6.071.557	Base do distribuidor	NA	1		
46247	F70Z6675AA	Anel do bujão cárter 14x20	AL	1		
11625C	BD9M6CO55A	Camisas	LT	4		
11632B		Borracha	BO	1		
11240B	65.583	Jogo borracha com chap. parafuso	CHBO	1	1	
R930005		Kit de retentores para motor completo				
R921003	88WM6571BB	Retentores de haste de válvulas 8,8x10,8x10,3	VI	8	8	
R933003	78MU6701B	Retentor traseiro do virabrequim 82x105x12	SI	1		
R934004	BD3M6700A	Retentor dianteiro do virabrequim 35x50x7	SI	1		

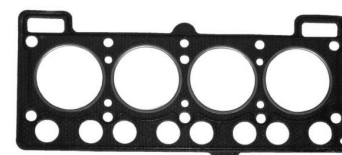

JL11802AG



JL11226

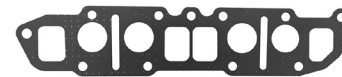

JL11821

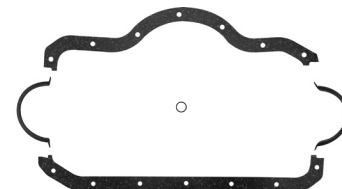

JL11816



JL11822F

JL11228

JL11832



JL11830

JL11831

JL11835



JL11236

JL11636

JL11234 (x2)

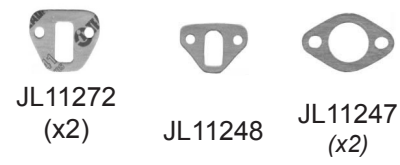

JL11272 (x2)

JL11248

JL11247 (x2)

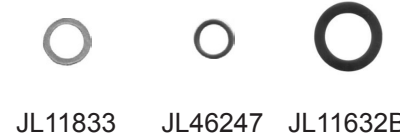

JL11833

JL46247

JL11632B

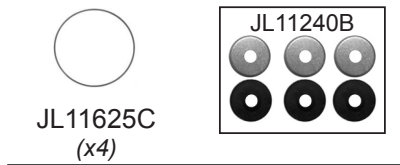

JL11625C (x4)

JL11240B

Itens Relacionados

<p>Juntas para Injeção Eletrônica</p> <p>JL15902 Jogo de juntas I.E. Gol 1000 Plus CFI Motor AE</p>	<p>Juntas para Injeção Eletrônica</p> <p>JL15906 Jogo de juntas I.E. Golf 1.8/gol 1000 Motor AP multipoint</p>	<p>Juntas para Carburador</p> <p>JL11860 Jg juntas carburador Escort CHT 86 Solex duplo</p>	<p>Kit de tampa de válvulas</p> <p>JL11226KTV Kit de tampa e vedador de válvulas Escort/ Escort/ Del Rey CHT - 7 peças</p>	<p>Em breve novidades</p>
---	--	---	--	---------------------------

R930005

R921003

R933003

R934004

Ford



Juntalima

Motor/Engine 1.6 16V Sigma Flex

Códigos jogos de juntas
Code set gaskets

Modelo / Model	Cm³	De	Até	Completo com retentores 11102CR	Full set with oil seals 11102CR
Focus	1596			Completo sem retentores 11102C	Full set without oil seals 11102C
New Fiesta (México)	1596			Kit retificação com retentores 11102KR	Head set with oil seals 11102KR
Ecosport	1596			Kit retificação sem retentores 11102K	Head set without oil seals 11102K



JL11102

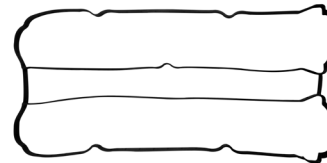

JL11027

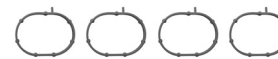

JL11023



JL11024

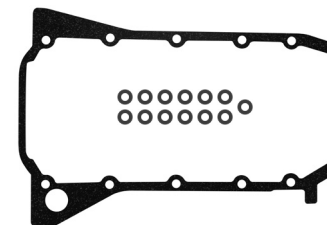

JL11516B



JL11997 JL11998 JL11991

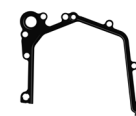

JL11889



JL11125



JL46247

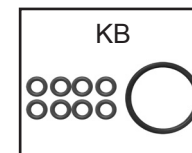

Código/Code	N° Original	Aplicação / application	MP	C	K	M
11102	7S7G6051CB	Cabeçote / cylinder head gasket	PAK	1	1	
11027	156G6K260AA	Tampa de válvulas / rocker cover gasket	BO	1	1	
11023	4M5G9441	Coletor de admissão / intake manifold	BO	4	4	
11024		Coletor de escapamento / exhaust manifold	CNAC	1	1	
11516B	969MM6710AD	Cárter com limitador / oil pan	CB	1		
11997	7M5Z8255A	Conexão da carcaça de água	BO	1		
11998	4M5G9P848	Corpo da borboleta	BO	1	1	
11991	BE8Z8255A	Válvula termostática / thermostatic valve	BO	1	1	
11889	BM5G6659A	Tampa da bomba de óleo	NA	1		
11125	256194451AC	Catalizador	CNAC	1	1	
46247	F70Z6675AA	Anel do bujão cárter 14x20	AL	1		
KB		Kit de borrachas / kit rubbers	KB	1	1	
R930002		Kit de retentores para motor completo				
R931002	96MM6571BE	Retentores de haste de válvulas 6x11x17,8	VI	16	16	16
R934003	96MM6K292	Retentor do comando de válvulas 38x52x6	SI	2	2	2
R932002	1143317	Retentor traseiro do virabrequim (flange)	PTFE	1	1	
R934002	1004457	Retentor dianteiro do virabrequim 33x47x5	SI	1	1	

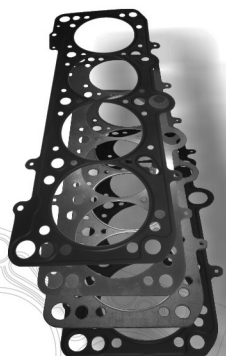

Juntalima
Indústria e Comércio de Auto Peças Ltda

**REFERÊNCIA NACIONAL
EM JUNTAS MLS**

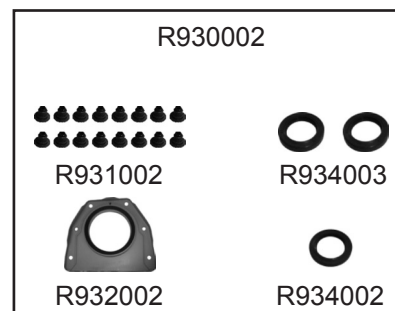

Ford



Juntalima

Motor/Engine 1.6 8V Zetec Rocam

Códigos jogos de juntas
Code set gaskets

Modelo / Model	Cm³	De	Até	Completo com retentores 11708CR	Full set with oil seals 11708CR
Fiesta	1598	1999		Completo sem retentores 11708C	Full set without oil seals 11708C
Courier	1598	2000		Completo MLS com retentores 11708CMR	Full set MLS with oil seals 11708CMR
Escort	1598	2000		Completo MLS sem retentores 11708CM	Full set MLS without oil seals 11708CM
Ecosport	1598	2003		Kit retificação com retentores 11708KR	Head set with oil seals 11708KR
				Kit retificação sem retentores 11708K	Head set without oil seals 11708K
				Kit retificação MLS com retentores 11708KMR	MLS Head set with oil seals 11708KMR
				Kit retificação MLS sem retentores 11708KM	MLS Head set without oil seals 11708KM

Código/Code	N° Original	Aplicação / application	MP	C	K	M
11702G	XS6E6051BE	Cabeçote / cylinder head gasket	PAK	1	1	
11702MLS	XS6E6584AB	Cabeçote / cylinder head gasket	MLS		1	1
11626	XS6E6584AB	Tampa de válvulas / rocker cover gasket	BO	1	1	1
11461MLS	XS6E9448BB	Coletor de escapamento / exhaust manifold	MLS	1	1	1
11520	XS6E441BA	Coletor de admissão / intake manifold	SI	2	2	2
11216AL	XS6E6710A2B	Cárter / oil pan	BOAL	1		1
11121	XS619451DC	Saída do escapamento / exhaust pipe	CNAC	1	1	1
11331	XS6E6659A2B	Tampa da distribuição / timing cover	NA	1	1	1
11843	XS6E8255BB	Carcaça termostática	SI	1	1	1
11333	XS6E6L621AD	Cabeçote do Filtro de óleo / oil filter	NA	1	1	1
11453		Anel de borracha oito (5022)	BO	1	1	1
KB		Kit de borrachas / kit rubbers	KB	1	1	1
R930001		Kit de retentores para motor completo				
R931001	XS6E6571AB	Retentores de haste de válvulas 6x11x17,8	VI	8	8	8
R932001	XS6E6K301BE	Retentor traseiro do virabrequim (flange)	VI	1		1
R934001	XS6E6700BA	Retentor dianteiro do virabrequim 40x62x8	SI	1		1

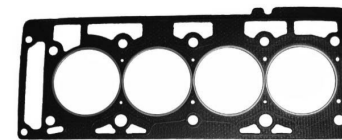

JL11702G

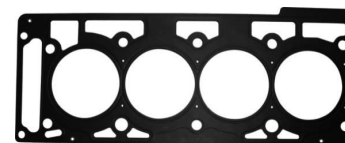

JL11702MLS

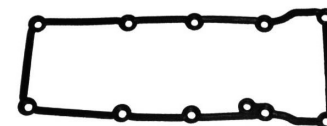

JL11626



JL11461MLS



JL11520(x2)

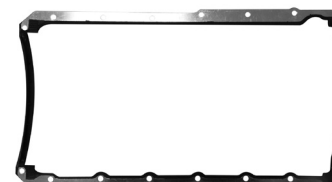

JL11216AL



JL11121



JL11331



JL11843



JL11333



JL11453

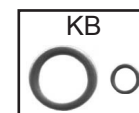

Itens Relacionados

Juntas para Injeção Eletrônica

Juntas para Diversas

JL11335
Junta do corpo do tubo da admissão de ar - Silicone
XS6E9P848AA

JL11331MLS
Tampa da distribuição Bomba d'água e óleo Zetec rocam 1.0/1.6 MLS

Em breve novidades

Em breve novidades

Em breve novidades

R930001

R931001

R932001

R934001

Ford



Juntalima

Motor/Engine 1.8 16V Zetec

Códigos jogos de juntas
Code set gaskets

Modelo / Model	Cm³	De	Até	Completo com retentores 11706CR	Full set with oil seals 11706CR
Escort	1796	1992		Completo sem retentores 11706C	Full set without oil seals 11706C
Fiesta	1796	1995		Completo MLS com retentores 11706CMR	Full set MLS with oil seals 11706CMR
Mondeo	1796	1993	1998	Completo MLS sem retentores 11706CM	Full set MLS without oil seals 11706CM
				Kit retificação com retentores 11706KR	Head set with oil seals 11706KR
				Kit retificação sem retentores 11706K	Head set without oil seals 11706K
				Kit retificação MLS com retentores 11706KMR	MLS Head set with oil seals 11706KMR
				Kit retificação MLS sem retentores 11706KM	MLS Head set without oil seals 11706KM

Código/Code	N° Original	Aplicação / application	MP	C	K	M
11902G	84AU6051	Cabeçote / cylinder head gasket	PAK	1	1	1
11902MLS	84AU6051	Cabeçote / cylinder head gasket	MLS	1	1	1
11526	928M6584C1B	Tampa de válvulas / rocker cover gasket	BO	1	1	1
11441	928M9441GB	Coletor de escapamento / exhaust manifold	PAK	1	1	1
11222	938M9448AA	Coletor de escapamento / exhaust manifold	CNAC	1	1	1
11451	928F9441DB	Coletor de admissão / intake manifold	NA	1	1	1
11320	988M9461MAA	Coletor de admissão / intake manifold	SI	4	4	4
11916	938M6710AC	Cárter / oil pan	BO	1	1	1
11723		Corpo da borboleta	NA	1	1	1
11729		Flange traseiro do virabrequim	NA	1	1	1
11999		Guarnição	NA	1	1	1
11130		Bomba d'água / water pump	NA	1	1	1
11296	7090340	Corpo da borboleta	NA	1	1	1
11297	16.63908	Pescador de óleo	NA	1	1	1
11298		Caixa termostato	NA	1	1	1
11452		Anel borracha oito (5022)	BO	1	1	1
11546B		Kit de vedadores / sealants kit	KT	1	1	1
R930003		Kit de retentores para motor completo				
R931004	958M6571BC/CC	Retentores de haste de válvulas 6x12x19,4	VI	16	16	16
R934005	928M6K292B5B	Retentor do comando de válvulas 42x53x7	SI	2	2	2
R933001	928M6700A5B	Retentor traseiro do virabrequim 88x108x10	SI	1	1	1
R724002	988M6700A5B	Retentor dianteiro do virabrequim 35x50x7	SI	1	1	1

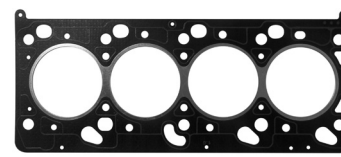

JL11902G

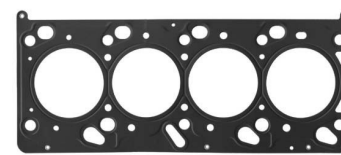

JL11902MLS

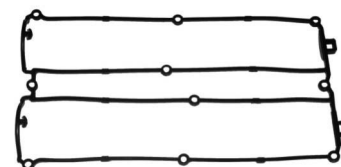

JL11526



JL11441



JL11222



JL11451

JL11320 (x4)

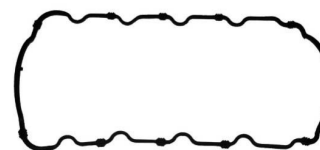

JL11916



JL11723

JL11729

JL11999



JL11130



JL11296



JL11297



JL11298



JL11452

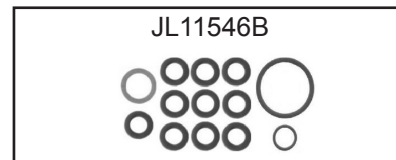

JL11546B

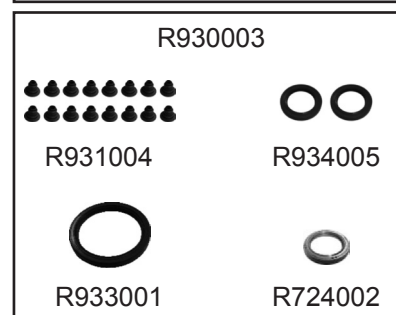

R930003



R931004



R934005



R933001



R724002



Juntalima
Indústria e Comércio de Auto Peças Ltda

- Juntas mls
- Juntas Metal-Elastômeto
- Juntas em Borracha
- Cortiças
- Retentores

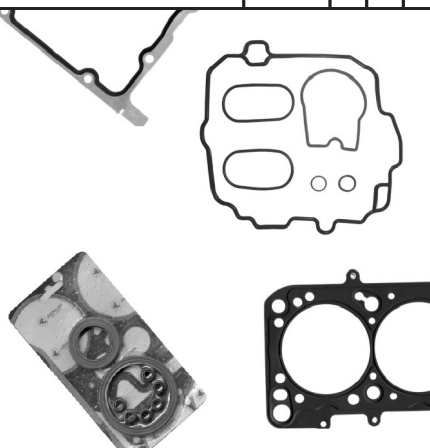

Ford



Juntalima

Motor/Engine 1.8 16V Zetec E

Códigos jogos de juntas
Code set gaskets

Modelo / Model	Cm³	De	Até
Focus	1796	2000	2005

Completo com retentores 11804CR	Full set with oil seals 11804CR
Completo sem retentores 11804C	Full set without oil seals 11804C
Completo MLS com retentores 11804CMR	Full set MLS with oil seals 11804CMR
Completo MLS sem retentores 11804CM	Full set MLS without oil seals 11804CM
Kit retificação com retentores 11804KR	Head set with oil seals 11804KR
Kit retificação sem retentores 11804K	Head set without oil seals 11804K
Kit retificação MLS com retentores 11804KMR	MLS Head set with oil seals 11804KMR
Kit retificação MLS sem retentores 11804KM	MLS Head set without oil seals 11804KM

Código/Code	Nº Original	Aplicação / application	MP	C	K	M
11902G	938M6051CE	Cabeçote / cylinder head gasket	PAK	1	1	
11902MLS	938M6051CE	Cabeçote / cylinder head gasket	MLS		1	1
11327	928M6584C1B	Tampa de válvulas / rocker cover gasket	BO	1	1	1
11031		Coletor de escapamento / exhaust manifold	CNAC	1	1	1
11287	928F9441DB	Injeção eletrônica	BO	1	1	1
11021	988M9461MAA	Coletor de admissão / intake manifold	SI	4	4	4
11217		Sobre cárter	NA	1		1
11117		Cárter / oil pan	CHBO	1		1
11725	73.787.88	Bomba de óleo / oil pump	NA	1		1
11729		Flange traseira do virabrequim	NA	1		1
11130		Bomba d'água / water pump	NA	1		1
11296	70.903.40	Corpo da borboleta	NA	1		1
11298		Caixa termostato	NA	1		1
11297	16.369.08	Pescador de óleo	NA	1		1
R930003		Kit de retentores para motor completo				
R931004	958M6571BC/CC	Retentores de haste de válvulas 6x12x19,4	VI	16	16	16
R934005	928M6K292B5B	Retentor do comando de válvulas 42x53x7	SI	2	2	2
R933001	928M6701B5B	Retentor traseiro do virabrequim 88x108x10	SI	1		1
R724002	988M6700A5B	Retentor dianteiro do virabrequim 35x50x7	SI	1		1

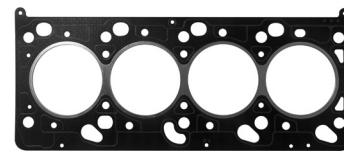

JL11902G

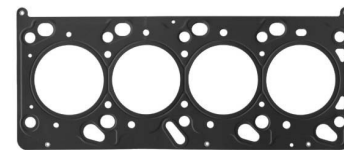

JL11902MLS

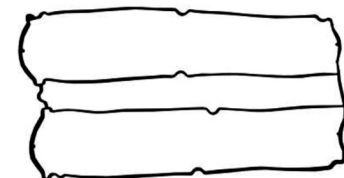

JL11327



JL11031

JL11287



JL11021

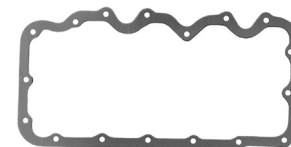

JL11217

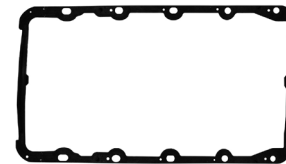

JL11117



JL11725



JL11729



JL11130



JL11296



JL11298



JL11297

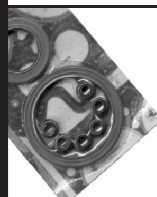

Juntalima
Indústria e Comércio de Auto Peças Ltda

**CONHEÇA NOSSA LINHA
DE RETENTORES**



R930003	
R931004	R934005
R933001	R724002

Ford



Juntalima

Motor/Engine 2.0 16V Zetec

Códigos jogos de juntas
Code set gaskets

Modelo / Model	Cm³	De	Até	Completo com retentores 11707CR	Full set with oil seals 11707CR
Mondeo	1989	1993		Completo sem retentores 11707C	Full set without oil seals 11707C
Escort	1989			Completo MLS com retentores 11707CMR	Full set MLS with oil seals 11707CMR
Contour	1989	1996	2000	Completo MLS sem retentores 11707CM	Full set MLS without oil seals 11707CM
Zx2	1989	1994		Kit retificação com retentores 11707KR	Head set with oil seals 11707KR
				Kit retificação sem retentores 11707K	Head set without oil seals 11707K
				Kit retificação MLS com retentores 11707KMR	MLS Head set with oil seals 11707KMR
				Kit retificação MLS sem retentores 11707KM	MLS Head set without oil seals 11707KM

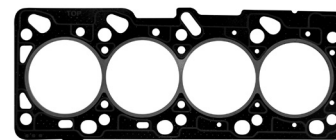

JL11903G

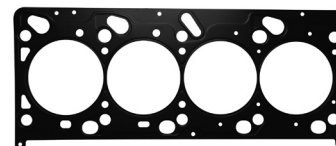

JL11903MLS

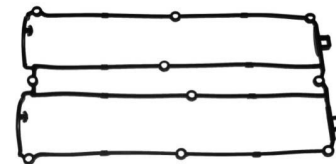

JL11526



JL11441



JL11222



JL11451



JL11320

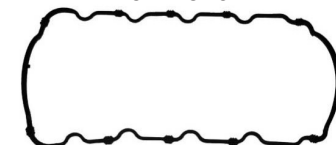

JL11916



JL11723

JL11729

JL11999



JL11130

JL11296

JL11297



JL11298

JL11452

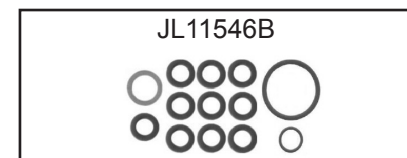

JL11546B

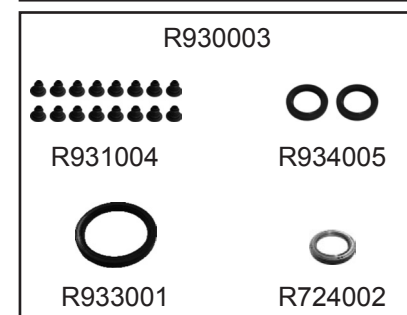

R930003



R931004



R934005



R933001



R724002

Código/Code	N° Original	Aplicação / application	MP	C	K	M
11903G	938M6051CE	Cabeçote / cylinder head gasket	PAK	1	1	
11903MLS	938M6051CE	Cabeçote / cylinder head gasket	MLS		1	1
11526	928M6584C1B	Tampa de válvulas / rocker cover gasket	BO	1	1	1
11441	928M9441GB	Coletor de escapamento / exhaust manifold	PAK	1	1	1
11222	938M9448AA	Coletor de escapamento / exhaust manifold	CNAC	1	1	1
11451	928F9441DB	Coletor de admissão / intake manifold	NA	1	1	1
11320	988M9461MAA	Coletor de admissão / intake manifold	SI	4	4	4
11916	938M6710AC	Cárter / oil pan	BO	1		1
11723		Corpo da borboleta	NA	1		1
11729		Flange traseiro do virabrequim	NA	1		1
11999		Guarnição	NA	1	1	1
11130		Bomba d'água / water pump	NA	1		1
11296	7090340	Corpo da borboleta	NA	1		1
11297	16.63908	Pescador de óleo	NA	1		1
11298		Caixa do termostato	NA	1		1
11452		Anel borracha oito (5022)	BO	1	1	1
11546B		Kit de vedadores / sealants kit	KT	1	1	1
R930003		Kit de retentores para motor completo				
R931004	958M6571BC/CC	Retentores de haste de válvulas 6x12x19,4	VI	16	16	16
R934005	928M6K292B5B	Retentor do comando de válvulas 42x53x7	SI	2	2	2
R933001	928M6700A5B	Retentor traseiro do virabrequim 88x108x10	SI	1		1
R724002	988M6700A5B	Retentor dianteiro do virabrequim 35x50x7	SI	1		1

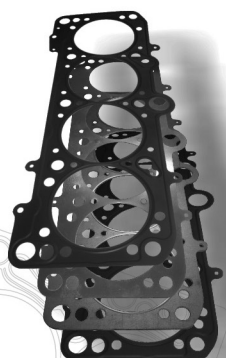

Juntalima
Indústria e Comércio de Auto Peças Ltda

**REFERÊNCIA NACIONAL
EM JUNTAS MLS**

Ford



Juntalima

Motor/Engine 2.0 16V Zetec E

Códigos jogos de juntas
Code set gaskets

Modelo / Model	Cm³	De	Até	Completo com retentores 11805CR	Full set with oil seals 11805CR
Focus RS	1988	2000	2005	Completo sem retentores 11805C	Full set without oil seals 11805C
Mondeo	1988	2000	2005	Completo MLS com retentores 11805CMR Completo MLS sem retentores 11805CM Kit retificação com retentores 11805KR Kit retificação sem retentores 11805K Kit retificação MLS com retentores 11805KMR Kit retificação MLS sem retentores 11805KM	Full set MLS with oil seals 11805CMR Full set MLS without oil seals 11805CM Head set with oil seals 11805KR Head set without oil seals 11805K MLS Head set with oil seals 11805KMR MLS Head set without oil seals 11805KM

Código/Code	Nº Original	Aplicação / application	MP	C	K	M
11903G	938M6051CE	Cabeçote / cylinder head gasket	PAK	1		
11903MLS	938M6051CE	Cabeçote / cylinder head gasket	MLS		1	1
11327	928M6584C1B	Tampa de válvulas / rocker cover gasket	BO	1	1	1
11021	928M9441GB	Coletor de admissão / intake manifold	SI	4	4	4
11031		Coletor de escapamento / exhaust manifold	CNAC	1	1	1
11217		Sobre cárter	NA	1		1
11117		Cárter / oil pan	CHBO	1		1
11287		Junta da injeção	BO	1		1
11725	73.787.88	Bomba de óleo / oil pump	NA	1		1
11729		Flange traseira do virabrequim	NA	1		1
11130		Bomba d'água / water pump	NA	1		1
11296	70.903.40	Corpo da borboleta	NA	1		1
11298		Caixa termostato	NA	1		1
11297	16.369.08	Pescador de óleo	NA	1		1
11452		Borracha anel oito (5020)	BO	1	1	1
R930003		Kit de retentores para motor completo				
R931004	958M6571BC/CC	Retentores de haste de válvulas 6x12x19,4	VI	16	16	16
R934005	928M6K292B5B	Retentor do comando de válvulas 42x53x7	SI	2	2	2
R933001	928M6701B5B	Retentor traseiro do virabrequim 88x108x10	SI	1		1
R724002	988M6700A5B	Retentor dianteiro do virabrequim 35x50x7	SI	1		1

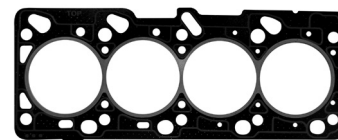

JL11903G

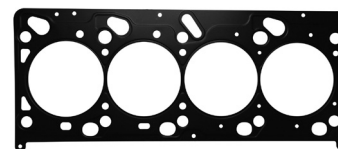

JL11903MLS

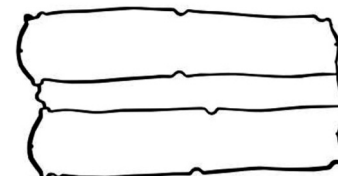

JL11327



JL11021



JL11031

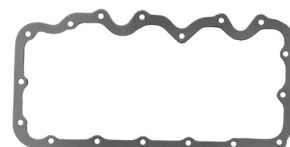

JL11217

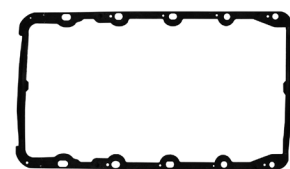

JL11117



JL11287



JL11725



JL11729



Ford



Juntalima

Motor/Engine 2.0 16V Duratec/CJBA

Códigos jogos de juntas
Code set gaskets

Modelo / Model	Cm³	De	Até	Completo com retentores 11901CR	Full set with oil seals 11901CR
Mondeo	1999	2000		Completo sem retentores 11901C	Full set without oil seals 11901C
Ecosport (DOHC)	1999	2003		Completo MLS com retentores 11901CMR	Full set MLS with oil seals 11901CMR
Fiesta	1999	2004		Completo MLS sem retentores 11901CM	Full set MLS without oil seals 11901CM
Focus	1999	2004		Kit retificação com retentores 11901KR	Head set with oil seals 11901KR
Fusion	1999	2004		Kit retificação sem retentores 11901K	Head set without oil seals 11901K
				Kit retificação MLS com retentores 11901KMR	MLS Head set with oil seals 11901KMR
				Kit retificação MLS sem retentores 11901KM	MLS Head set without oil seals 11901KM



JL11909



JL11909MLS

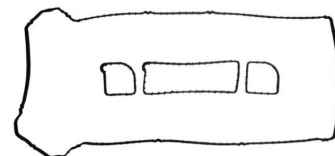

JL11246



JL11223(x4)



JL11123MLS



JL11124



JL11145



JL11146



JL11147



JL11148



JL11149



JL11135



JL11136



JL11137



JL11138



JL11139(x2)



JL11151(x2)



JL23014

R930007

R931003

R932003

R934008

Código/Code	N° Original	Aplicação / application	MP	C	K	M
11909		Cabeçote / cylinder head gasket	PAK	1	1	
11909MLS		Cabeçote / cylinder head gasket	MLS			1
11246		Jogo da tampa de válvulas / kit for rocker cover	BO	1	1	1
11223		Coletor de admissão / intake manifold	BO	4	4	4
11123MLS		Coletor de escapamento / exhaust manifold	MLS	1	1	1
11124		Saída do escapamento / exhaust pipe	CNAC	1	1	1
11145		Guarnição	BO	1	1	1
11146		Guarnição	BO	1		1
11147		Guarnição	BO	1	1	1
11148		Guarnição	MLS	1	1	1
11149		Guarnição	MLS	1	1	1
11135		Guarnição	MLS	1	1	1
11136		Guarnição	MLS	1	1	1
11137		Guarnição	BO	1	1	1
11138		Guarnição	BO	1	1	1
11139		Guarnição	MLS	2	2	2
11151		Guarnição	BO	2		2
23014		Anel de borracha	BO	1		1
R930007		Kit de retentores para motor completo	KA	1	1	1
R931003		Retentor haste de válvulas 4,5x11x17,5	VI	16	16	16
R932003		Retentor traseiro do virabrequim (flange)	PTFE	1		1
R934008		Retentor dianteiro 37x50x8	SI	1		1

Juntalima

Indústria e Comércio de Auto Peças Ltda

CONHEÇA NOSSA LINHA DE RETENTORES

Ford



Juntalima

Motor/Engine 2.0/2.3 16V Duratec/CBJA

Códigos jogos de juntas
Code set gaskets

Tampa de válvula de alumínio

Modelo / Model Cm³ De Até

Mondeo	1999	2000	
Ecosport (DOHC)	1999	2003	
Ranger (DOHC)	2260	2007	

Completo com retentores 11909CR	Full set with oil seals 11909CR
Completo sem retentores 11909C	Full set without oil seals 11909C
Completo MLS com retentores 11909CMR	Full set MLS with oil seals 11909CMR
Completo MLS sem retentores 11909CM	Full set MLS without oil seals 11909CM
Kit retificação com retentores 11909KR	Head set with oil seals 11909KR
Kit retificação sem retentores 11909K	Head set without oil seals 11909K
Kit retificação MLS com retentores 11909KMR	MLS Head set with oil seals 11909KMR
Kit retificação MLS sem retentores 11909KM	MLS Head set without oil seals 11909KM

Código/Code	Nº Original	Aplicação / application	MP	C	K	M
11909		Cabeçote / cylinder head gasket	PAK	1		
11909MLS		Cabeçote / cylinder head gasket	MLS		1	1
11256		Kit da tampa de válvulas / kit for rocker cover	BO	1	1	1
11223		Coletor de admissão / intake manifold	BO	4	4	4
11123MLS		Coletor de escapamento / exhaust manifold	MLS	1	1	1
11124		Saída do escapamento / exhaust pipe	CNAC	1	1	1
11145		Guarnição	BO	1	1	1
11146		Guarnição	BO	1		1
11147		Guarnição	BO	1	1	1
11148		Guarnição	MLS	1	1	1
11149		Guarnição	MLS	1	1	1
11135		Guarnição	MLS	1	1	1
11136		Guarnição	MLS	1	1	1
11137		Guarnição	BO	1	1	1
11138		Guarnição	BO	1		1
11139		Guarnição	MLS	2		2
11151		Guarnição	BO	2		2
23014		Anel de borracha	BO	1	1	1
R930007		Kit de retentores para motor completo	KA	1	1	1
R931003		Retentor de haste de válvula 4,5x11x17,5	VI	16	16	16
R932003		Retentor traseiro do virabrequim (flange)	PTFE	1		1
R934008		Retentor dianteiro 37x50x8	SI	1		1



JL11909



JL11909MLS

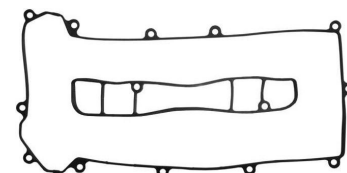

JL11256



JL11223(x4)



JL11123MLS



JL11124



JL11145



JL11146



JL11147



JL11148



JL11149



JL11135



JL11136



JL11137



JL11138



JL11139(x2)



JL11151(x2)



JL23014



Juntalima
Indústria e Comércio de Auto Peças Ltda

- Juntas mls
- Juntas Metal-Elastômeto
- Juntas em Borracha
- Cortiças
- Retentores

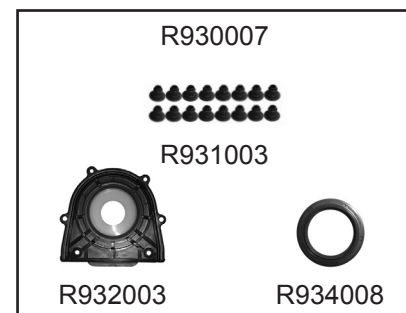
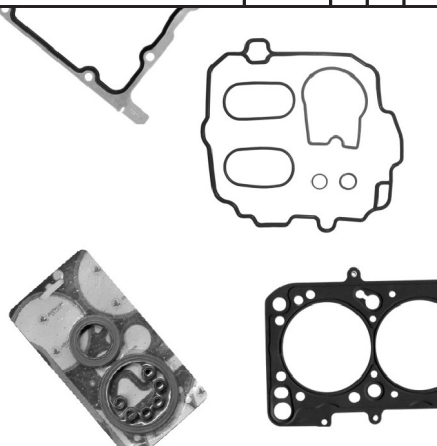

Ford



Juntalima

Motor/Engine 2.2 16V GBVAJPF/ QW/ QJ
2.2 16V DRRA/ B/ C
2.2 16V USRA/ B
2.2 16V CVRA/ B/ C

Modelo / Model Cm³ De Até
Ranger 2198 2011
Transit 2198 2011 2014

Códigos jogos de juntas
Code set gaskets

Completo com retentores 11100CR	Full set with oil seals 11100CR
Completo sem retentores 11100C	Full set without oil seals 11100C
Completo MLS com retentores 11100CMR	Full set MLS with oil seals 11100CMR
Completo MLS sem retentores 11100CM	Full set MLS without oil seals 11100CM
Kit retificação com retentores 11100KR	Head set with oil seals 11100KR
Kit retificação sem retentores 11100K	Head set without oil seals 11100K
Kit retificação MLS com retentores 11100KMR	MLS Head set with oil seals 11100KMR
Kit retificação MLS sem retentores 11100KM	MLS Head set without oil seals 11100KM

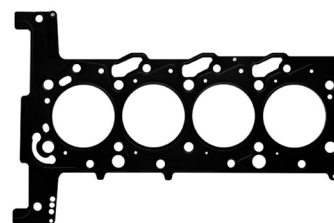

JL11100/ JL11100MLS1
JL11100MLS2



JL11427

Código/Code	N° Original	Aplicação / application	MP	C	K	M
11100		Cabeçote / cylinder head gasket	PAK	1	1	
11100MLS1		Cabeçote / cylinder head gasket (1,10 mm)	MLS			1
11100MLS2		Cabeçote / cylinder head gasket (1,20 mm)	MLS	1	1	1
11427	1099778	Tampa de válvulas / rocker cover gasket	BO	1	1	1
11224	1138392	Coletor de admissão / intake manifold	BO	8	8	8
11424	13492500	Coletor de escapamento / exhaust manifold	CNAC	1	1	1
11752		Tubo do escapamento	CNAC	1	1	1
11753		Guarnição	CNAC	1	1	1
11754		Guarnição	NA	1	1	1
11317	1228836	Cárter / oil pan	NA	1	1	1
11755		Guarnição	NA	1	1	1
11756		Guarnição	NA	1	1	1
11757		Guarnição	CNAC	1	1	1
11758		Guarnição	CNAC	1	1	1
11759		Guarnição	CNAC	1	1	1
11760		Guarnição	CNAC	1	1	1
11761		Guarnição	CNAC	1	1	1
11762		Guarnição	CNAC	1	1	1
11763		Guarnição	CNAC	2	2	2
11764		Guarnição	BO	1	1	1
KB060		Kit de borrachas / Kit rubbers	KT	1	1	1
R930011		Kit de retentores para motor completo	KT			
R931010		Retentores de haste de válvulas 7x12x19,5	VI	16	16	16
R932006	1117435	Retentor traseiro do virabrequim flange	SI	1	1	1
R934011	1116905	Retentor dianteiro / comando 50x90x8,5/ 13,5	SI	1	1	1



JL11224



JL11424



JL11752 JL11753 JL11754

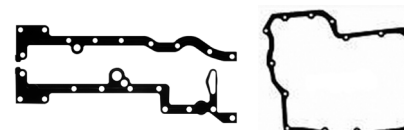

JL11317

JL11755

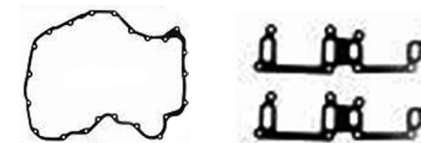

JL11756

JL11757



JL11758

JL11759

JL11760



JL11761

JL11762

JL11763



JL11764



JLKB060



- Juntas mls
- Juntas Metal-Elastômeto
- Juntas em Borracha
- Cortiças
- Retentores

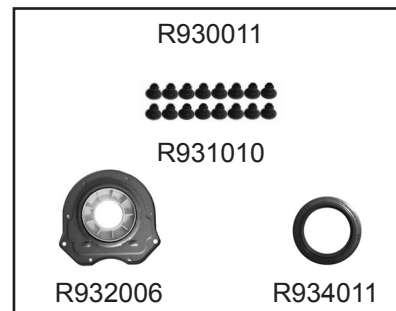
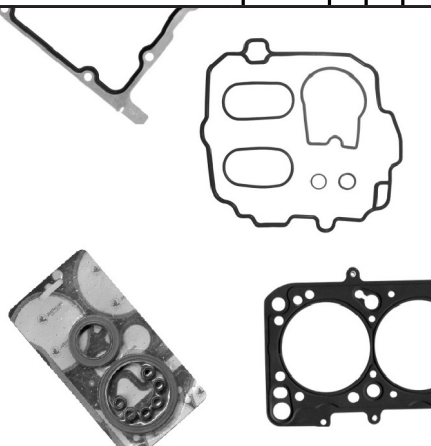

R930011

R931010

R932006

R934011

Ford



Juntalima

Motor/Engine 2.4 16V DOFA
2.4 16V FXFA
2.4 16V FAA/ B/ C/ D
2.4 16V H9FA/ B / D

Códigos jogos de juntas
Code set gaskets

Completo com retentores 11103CR	Full set with oil seals 11103CR
Completo sem retentores 11103C	Full set without oil seals 11103C
Completo MLS com retentores 11103CMR	Full set MLS with oil seals 11103CMR
Completo MLS sem retentores 11103CM	Full set MLS without oil seals 11103CM
Kit retificação com retentores 11103KR	Head set with oil seals 11103KR
Kit retificação sem retentores 11103K	Head set without oil seals 11103K
Kit retificação MLS com retentores 11103KMR	MLS Head set with oil seals 11103KMR
Kit retificação MLS sem retentores 11103KM	MLS Head set without oil seals 11103KM

Modelo / Model	Cm³	De	Até
Transit DI	2402	2001	2006
Transit TDCI	2402	2000	2006

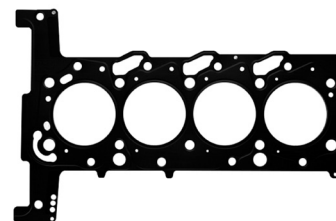

JL11103/ JL11103MLS1
JL11103MLS2



JL11427



JL11224



JL11424



JL11752



JL11753



JL11754

Código/Code	Nº Original	Aplicação / application	MP	C	K	M
11103		Cabeçote / cylinder head gasket	PAK	1	1	
11103MLS1		Cabeçote / cylinder head gasket (1,10 mm)	MLS			1
11103MLS2		Cabeçote / cylinder head gasket (1,20 mm)	MLS	1	1	1
11427	1099778	Tampa de válvulas / rocker cover gasket	BO	1	1	1
11224	1138392	Coletor de admissão / intake manifold	BO	8	8	8
11424	13492500	Coletor de escape / exhaust manifold	CNAC	1	1	1
11752		Tubo do escape	CNAC	1	1	1
11753		Guarnição	CNAC	1	1	1
11754		Guarnição	NA	1	1	1
11317	1228836	Cárter / oil pan	NA	1	1	1
11755		Guarnição	NA	1	1	1
11756		Guarnição	NA	1	1	1
11757		Guarnição	CNAC	1	1	1
11758		Guarnição	CNAC	1	1	1
11759		Guarnição	CNAC	1	1	1
11760		Guarnição	CNAC	1	1	1
11761		Guarnição	CNAC	1	1	1
11762		Guarnição	CNAC	1	1	1
11763		Guarnição	CNAC	2	2	2
11764		Guarnição	BO	1	1	1
KB060		Kit de borrachas / Kit rubbers	KT	1	1	1
R930011		Kit de retentores para motor completo	KT			
R931010		Retentores de haste de válvulas 7x12x19,5	VI	16	16	16
R932006	1117435	Retentor traseiro do virabrequim flange	SI	1	1	1
R934011	1116905	Retentor dianteiro / comando 50x90x8,5/ 13,5	SI	1	1	1

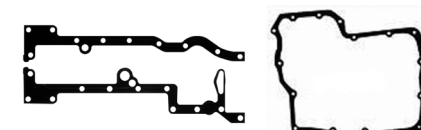

JL11317



JL11755

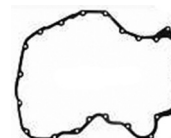

JL11756

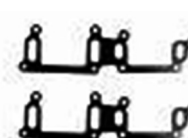

JL11757



JL11758



JL11759



JL11760



JL11761



JL11762



JL11763



JL11764



JLKB060

R930011



R931010



R932006



R934011



Juntalima
Indústria e Comércio de Auto Peças Ltda

- Juntas mls
- Juntas Metal-Elastômeto
- Juntas em Borracha
- Cortiças
- Retentores

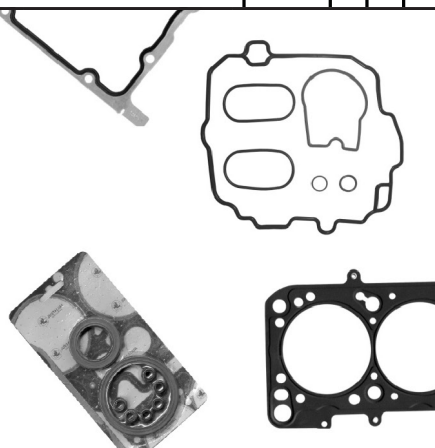

NOVO

Ford



Juntalima

Motor/Engine 2.3/ 2.5 8V OHC/ WHT

Códigos jogos de juntas
Code set gaskets

Modelo / Model	Cm³	De	Até
F100			
Maverick			
Ranger			

Completo sem retentores
11306C
Kit retificação sem retentores
11306K

Full set without oil seals
11306C
Head set without oil seals
11306K

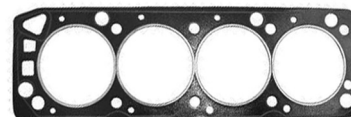

JL11306

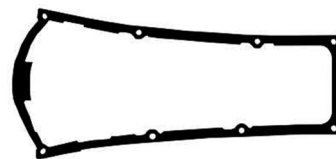

JL11127



JL11423



JL11623



JL11323

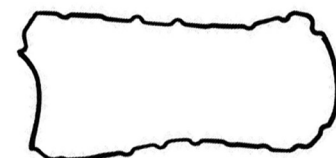

JL11036



JL11336



JL11983



JL54263



JL11339



JL11984



JL11982

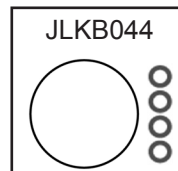

JLKB044

Código/Code	N° Original	Aplicação / application	MP	C	K	M
11306		Cabeçote / cylinder head gasket	PAK	1	1	
11127		Tampa de válvulas / rocker cover gasket	BO	1	1	
11423		Coletor de admissão / intake manifold	NA	1	1	
11623		Coletor de admissão / intake manifold	PAK	1	1	
11323		Coletor de escapamento / exhaust manifold	CNAC	1	1	
11036		Cárter / oil pan	BO	1		
11336		Bomba de óleo / oil pump	NA	1	1	
11983		Longarina	BO	1		
54263		Guarnição	NA	1		
11339		Guarnição	NA	1		
11984		Guarnição	CNAC	1		
11982		Guarnição	NA	1		
JLKB044		Kit de borrachas / Kit rubbers 5 peças	KB	1	1	

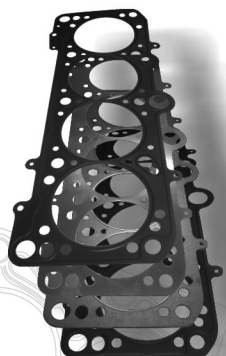

Juntalima
Indústria e Comércio de Auto Peças Ltda

**REFERÊNCIA NACIONAL
EM JUNTAS MLS**



Motor/Engine 2.5 8V Maxion TDI

Códigos jogos de juntas
Code set gaskets

Modelo / Model	Cm³	De	Até	Completo com retentores 016119CR	Full set with oil seals 016119CR
Sprinter	2495	1997		Completo sem retentores 016119C	Full set without oil seals 016119C
Blazer	2507	1995		Completo MLS com retentores 016119CMR	Full set MLS with oil seals 016119CMR
S10	2507	1995		Completo MLS sem retentores 016119CM	Full set MLS without oil seals 016119CM
Ranger	2507	1995		Kit retificação com retentores 016119KR	Head set with oil seals 016119KR
				Kit retificação sem retentores 016119K	Head set without oil seals 016119K
				Kit retificação MLS com retentores 016119KMR	MLS Head set with oil seals 016119KMR
				Kit retificação MLS sem retentores 016119KM	MLS Head set without oil seals 016119KM

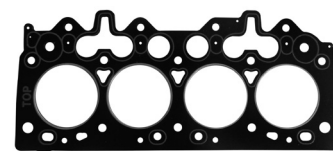

JL016119MP

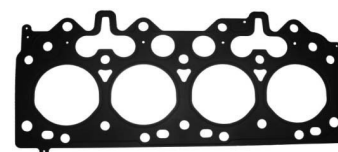

JL11906MLS1
JL11906MLS2/ JL11906MLS3



JL016726



JL016925



JL016916B



JL016928

JL016927



JL48963

JL016341

JL016344 (x2)



JL11150

JL016123

JL016345



JL016340

JL016347

JL016348



JL016929

JL016343(x2)

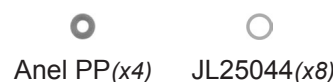

Anel PP(x4)

JL25044(x8)

Código/Code	Nº Original	Aplicação / application	MP	C	K	M
016119MP		Cabeçote / cylinder head gasket Metalopak	MPAK	1	1	
11906MLS1		Cabeçote / cylinder head gasket - pico1,35mm	MLS		1	1
11906MLS2		Cabeçote / cylinder head gasket - pico1,45mm	MLS		1	1
11906MLS3		Cabeçote / cylinder head gasket - pico1,60mm	MLS		1	1
016726		Tampa de válvulas / rocker cover gasket	BO	1	1	1
016925		Coletor de escapamento / exhaust manifold	CNAC	1	1	1
016916B		Cárter com limitador / oil pan	CB	1		1
016928		Tampa distribuição dianteira	NA	1		1
016927		Distribuição ao bloco	NA	1		1
48963		Guarnição	NA	1		1
016341		Guarnição	NA	1		1
016344		Guarnição	NA	2	2	2
11150		Guarnição	NA	1	1	1
016123		Superior bomba do óleo	NA	1	1	1
016345		Guarnição	NA	1		1
016340		Guarnição	NA	1		1
016347		Guarnição	NA	1		1
016348		Guarnição	NA	1		1
016929		Bomba d'água / water pump	NA	1		1
016343		Guarnição	NA	2		2
25044		Arruela 7,15x1,5	AL	8		8
		Anel PP	PP	4		4
R760001		Kit de retentores para motor completo				
R761001		Retentores de haste de válvulas 7x11,5x10,5	VI	8	8	8
R764002		Retentor do comando de válvulas 47x62x9	SI	1	1	1
R762001		Retentor traseiro do virabrequim (flange)	PTFE	1		1
R764005		Retentor dianteiro 58x74x8,5	SI	1		1
R764001		Retentor distribuição 56x71x9	SI	1		1

Itens Relacionados

Junta para Cabeçote

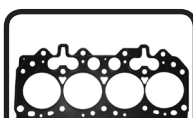

JL11908MLS
Junta do cabeçote
MLS Ranger TD
Power Stroke 2.8

Em breve novidades

Em breve novidades

Em breve novidades

Em breve novidades

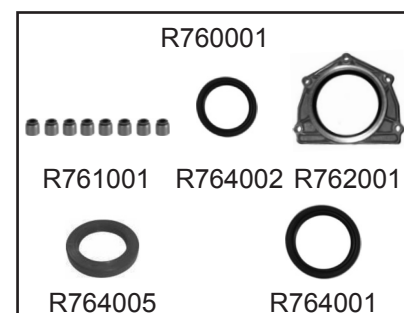

R760001

R761001

R764002

R762001

R764005

R764001

Ford



Juntalima

Motor/Engine 2.8 8V Power Stroke

Códigos jogos de juntas
Code set gaskets

Modelo / Model	Cm³	De	Até	Completo MLS com retentores 11908CMR	Full set MLS with oil seals 11908CMR
Ranger TD (Brasil)	2758	2002		Completo MLS sem retentores 11908CM	Full set MLS without oil seals 11908CM
				Completo c/ retentores s/ cabeçote 11908SCR	Full set w/o cyl. head gasket with oil seals 11908SCR
				Completo sem cabeçote 11908SC	Full set without cyl. head gasket 11908SC
				Kit retificação MLS com retentores 11908KMR	MLS Head set with oil seals 11908KMR
				Kit retificação MLS sem retentores 11908KM	MLS Head set without oil seals 11908KM
				Kit sem cabeçote com retentores 11908KSCR	Head set w/o head gasket with seals 11908KSCR
				Kit retificação sem cabeçote 11908KSC	Retification kit without head gasket 11908KSC

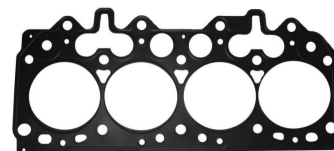

JL11908MLS1/ JL11908MLS2/ JL11908MLS3



JL016726



JL016925

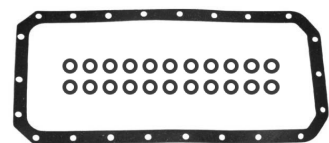

JL016916B



JL016928



JL016927



JL48963



JL016341



JL016344(x2)



JL11150



JL016123



JL016345



JL016340



JL016347



JL016348



JL016929



JL016343 (x2)



Anel PP (x4)

Código/Code	N° Original	Aplicação / application	MP	C	K	M	P
11908MLS1		Cabeçote / cylinder head gasket- pico1,35mm	MLS				
11908MLS2		Cabeçote / cylinder head gasket- pico1,45mm	MLS				
11908MLS3		Cabeçote / cylinder head gasket- pico1,60mm	MLS				
016726		Tampa de válvulas / rocker cover gasket	BO	1	1	1	1
016925		Coletor de escapamento / exhaust manifold	CNAC	1	1	1	1
016916B		Cárter com limitador / oil pan	CB	1	1	1	1
016928		Tampa distribuição dianteira	NA	1	1	1	1
016927		Distribuição ao bloco	NA	1	1	1	1
48963		Guarnição	NA	1	1	1	1
016341		Guarnição	NA	1	1	1	1
016344		Guarnição	NA	2	2	2	2
11150		Guarnição	NA	1	1	1	1
016123		Superior bomba do óleo	NA	1	1	1	1
016345		Guarnição	NA	1	1	1	1
016340		Guarnição	NA	1	1	1	1
016347		Guarnição	NA	1	1	1	1
016348		Guarnição	NA	1	1	1	1
016929		Bomba d'água / water pump	NA	1	1	1	1
016343		Guarnição	NA	2	2	1	1
		Anel PP	PP	4	4	1	1
R760001		Kit de retentores para motor completo	VI	8	8	8	8
R761001		Retentores de haste de válvulas 7x11,5x10,5	SI	1	1	1	1
R764002		Retentor do comando de válvulas 47x62x9	PTFE	1	1	1	1
R762001		Retentor traseiro do virabrequim (flange)	SI	1	1	1	1
R764005		Retentor dianteiro 58x74x8,5	SI	1	1	1	1
R764001		Retentor distribuição 56x71x9	SI	1	1	1	1



Juntalima
Indústria e Comércio de Auto Peças Ltda

- Juntas mls
- Juntas Metal-Elastômeto
- Juntas em Borracha
- Cortiças
- Retentores

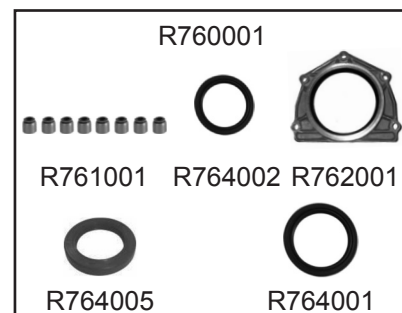
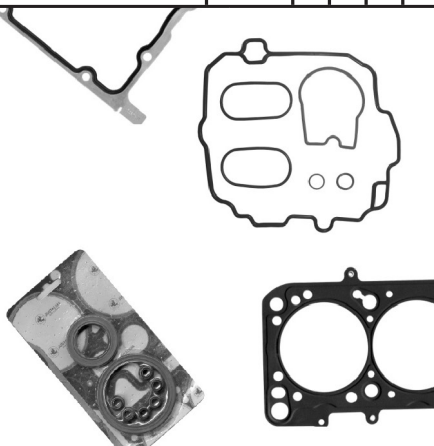

Ford



Juntalima

Motor/Engine 3.0 16V Power Stroke

Códigos jogos de juntas
Code set gaskets

Modelo / Model Cm³ De Até

Completo c/ retentores s/ cabeçote 11900SCR	Full set w/o cyl. head gasket with oil seals 11900SCR
Completo sem cabeçote 11900SC	Full set without cyl. head gasket 11900SC
Kit retificação sem cabeçote 11900KSC	Retification kit without head gasket 11900KSC

Ranger 2978

Código/Code	Nº Original	Aplicação / application	MP	C	K	M
11900-1	70490793	Cabeçote / cylinder head gasket 1,30 mm	PAK			
11900-2	70490792	Cabeçote / cylinder head gasket 1,50 mm	PAK			
11900-3	70490791	Cabeçote / cylinder head gasket 1,70 mm	PAK			
11936	70490701	Tampa de válvulas / rocker cover gasket	BO	1	1	
11924	70490700	Adaptadores injetores	BO	4	4	
11936K	70490786	Kit tampa de válvulas / rocker cover gasket set	KIT			
11923	70490786	Coletor de admissão / intake manifold	CNAC	4	4	
11922	70490785	Coletor de escapamento / exhaust manifold	CNAC	4	4	
11970		Distribuição	BO	1	1	
11971	70490824	Tampa da distribuição	PAK	1		
11972	70490709	Guarnição sucção ao óleo	BO	1	1	
11973	70490704	Guarnição conexão entrada de água	BO	1	1	
11974	70490692	Flange levantamento dianteiro	NA	1		
11975	70490708	Entrada de água ao bloco	BO	1		
11976		Guarnição	NA	1		
11978	70590021	Anel fechamento tampa injetora da distribuição	BO	1		
11979		Guarnição de fechamento	BO	1		
11980		Tubulação de água	NA	1		
11981	70490814	Bomba injetora	BO	1		
JLKA		Kit de arruelas	KA	1	1	
JLKB		Kit de borrachas / Kit rubbers	KB	1	1	
R930009		Kit de retentores de motor completo				
R931008		Retentores de haste de válvulas 5,2x11,7x20	VI	16	16	
R932004		Retentor da flange traseira	VI	1		
R934009		Retentor dianteiro 60,71x79,39x9,5	VI	1		

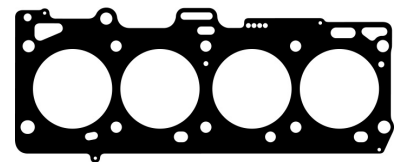

JL11900-1 / JL11900-2 / JL11900-3

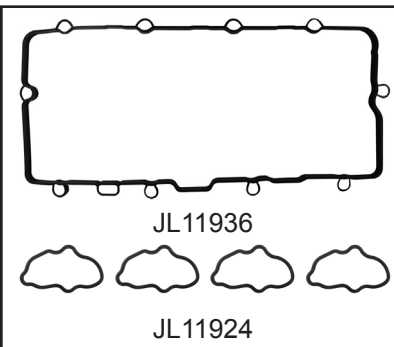

JL11936

JL11924

JL11936K



JL11923



JL11922



JL11970

JL11971



JL11972

JL11973

JL11974

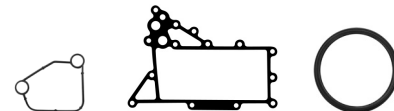

JL11975

JL11976

JL11978



JL11979

JL11980

JL11981



JLKA

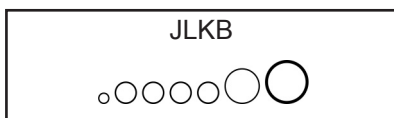

JLKB

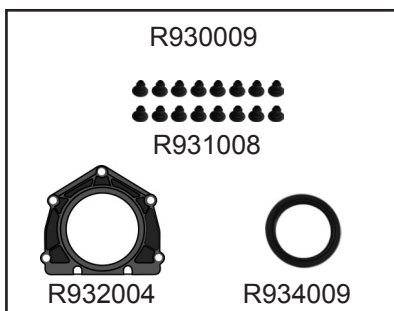

R930009



R931008

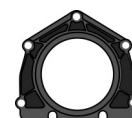

R932004



R934009

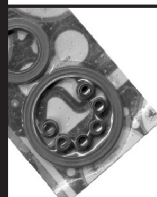

Juntalima
Indústria e Comércio de Auto Peças Ltda

CONHEÇA NOSSA LINHA DE RETENTORES



Ford



Juntalima

Motor/Engine 3.0 12V V6 244

Códigos jogos de juntas
Code set gaskets

Modelo / Model	Cm³	De	Até
Willys Jeep	3015	1973	
Maverick	3015	1973	
Explorer	3015	1973	

Completo sem retentores
13306C
Kit retificação sem retentores
13306K

Full set without oil seals
13306C
Head set without oil seals
13306K



JL13301



JL13337



JL13326

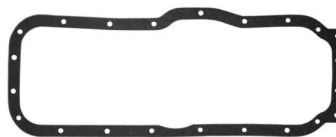

JL13317

Código/Code	N° Original	Aplicação / aplicação	MP	C	K	M
13301	801418	Cabeçote / cylinder head gasket	PAK	1	1	
13337	11.492	Tampa de válvulas / rocker cover gasket	CB	1	1	
13326	11.489	Tampa de válvulas lateral	CB	2	2	
13317	11.488	Cárter / oil pan	CB	1		
13321	805592	Junta do escapamento	PAK	1	1	
13327	11.490	Tampa da distribuição / timing cover	CB	1		
13328	11.496	Tampa dianteira do bloco	GV	1		
13330	11.485	Bomba d'água / water pump	GV	1		
13331		Guarnição	GV	1		
13332		Guarnição	GV	1		
13333	11.487	Tampa entrada d'água ao cabeçote	GV	1		
13348		Bomba de gasolina / gasoline pump	GV	1	1	
13335	11.493	Suporte boia cárter	GV	1		
13393		Base do carburador / Base carburetor	NA	2	2	
11900		Coletor do tubo do escapamento	CB	2		
13379	B24489	Gaxeta do mancal	NAGR	2		
KA		Kit de arruelas / kit washers e borracha	KT	1	1	

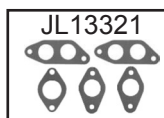

JL13321



JL13327



JL13328



JL13330



JL13331



JL13332



JL13333



JL13348



JL13335



JL13393 (x2)



JL11900 (x2)



JL13379 (x2)

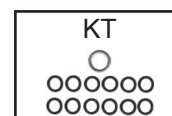

KT

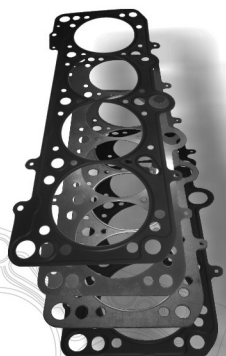

Juntalima
Indústria e Comércio de Auto Peças Ltda

**REFERÊNCIA NACIONAL
EM JUNTAS MLS**

Ford



Juntalima

Motor/Engine 4.0 12V V6 244

Códigos jogos de juntas
Code set gaskets

Modelo / Model	Cm³	De	Até	Completo com retentores 11304CR	Full set with oil seals 11304CR
Ranger	3996	1990	1994	Completo sem retentores 11304C	Full set without oil seals 11304C
Aerostar	3996	1990	1994	Kit retificação com retentores 11304KR	Head set with oil seals 11304KR
Explorer	3996	1990	1994	Kit retificação sem retentores 11304K	Head set without oil seals 11304K
Bronco II	3996	1990	1994		



JL11905G



JL11904G

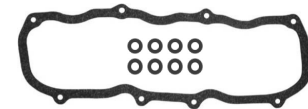

JL11926B(x2)



JL11422(x2)



JL11322 (x2)

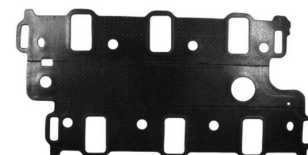

JL11324



JL11116

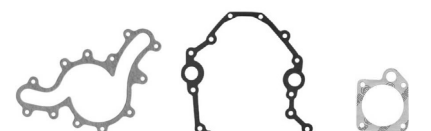

JL11930

JL11933

JL11213



JL11550



JL11336



JL25022

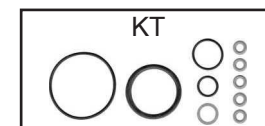

KT

R930006



R931006



R933004



R934007

Código/Code	N° Original	Aplicação / application	MP	C	K	M
11905G		Cabeçote esquerdo/ head gaskets left	PAK	1	1	
11904G		Cabeçote direito / head gaskets right	PAK	1	1	
11926B		Tampa de válvulas com limitador / rocker cover	CB	2	2	
11422		Coletor de escapamento / exhaust manifold	CNAC	2	2	
11322		Coletor de admissão / intake manifold	NA	2	2	
11324		Coletor de admissão / intake manifold	PAK	1	1	
11116		Cárter / oil pan	CB	1		
11930		Tampa da bomba de óleo	NA	1		
11933		Tampa da distribuição / timing cover	NA	1		
11213		Corpo da válvula	NA	1		
11550		Entrada de óleo	NA	1		
11336		Tampa do corpo da válvula	NA	1		
25022		Arruela 16x22x1,5	AL	1	1	
KT		Kit de borrachas e arruelas	KT	1	1	
R930006		Kit de retentores de motor completo				
R931006		Kit de retentores de haste de válvulas 7x11,5x9,5	VI	12	12	
R933004		Retentor traseiro do virabrequim 60,3x76,2x11,1	SI	1		
R934007		Retentor dianteiro do virabrequim 42x56x7	SI	1		

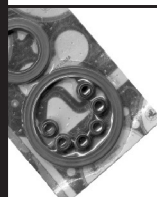

Juntalima
Indústria e Comércio de Auto Peças Ltda

**CONHEÇA NOSSA LINHA
DE RETENTORES**



Ford



Juntalima

Motor/Engine 4.0 12V V6 244

Códigos jogos de juntas
Code set gaskets

Modelo / Model	Cm³	De	Até	Completo com retentores 11305CR	Full set with oil seals 11305CR
Ranger	3996	1994	1996	Completo sem retentores 11305C	Full set without oil seals 11305C
Aerostar	3996	1994	1996	Kit retificação com retentores 11305KR	Head set with oil seals 11305KR
Explorer	3996	1994	1996	Kit retificação sem retentores 11305K	Head set without oil seals 11305K

Código/Code	N° Original	Aplicação / application	MP	C	K	M
11905G		Cabeçote esquerdo / head gaskets left	PAK	1	1	
11904G		Cabeçote direito / head gaskets right	PAK	1	1	
11926B		Tampa de válvulas com limitador / rocker cover	CB	2	2	
11422		Coletor de escapamento / exhaust manifold	CNAC	2	2	
11322		Coletor de admissão / intake manifold	NA	2	2	
11325		Coletor de admissão / intake manifold	PAK	1	1	
11116		Cárter / oil pan	CB	1		
11930		Tampa da bomba de óleo	NA	1		
11933		Tampa da distribuição / timing cover	NA	1		
11213		Corpo da válvula	NA	1		
11550		Entrada de óleo	NA	1		
11336		Tampa do corpo da válvula	NA	1		
25022		Arruela 16x22x1,5	AL	1	1	
KT		Kit de borrachas e arruelas	KT	1	1	
R930006		Kit de retentores de haste de válvulas completo				
R931006		Kit de retentores de haste de válvulas 7x11,5x9,5	VI	12	12	
R933004		Retentor traseiro do virabrequim 60,3x76,2x11,1	SI	1		
R934007		Retentor dianteiro do virabrequim 42x56x7	SI	1		



JL11905G



JL11904G



JL11926B(x2)



JL11422(x2)



JL11322 (x2)

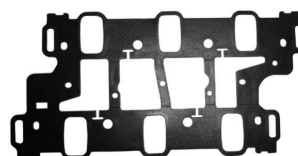

JL11325



JL11116



JL11930

JL11933

JL11213



JL11550



JL11336



JL25022

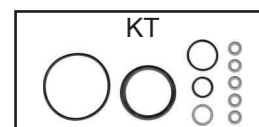

R930006



R931006



R933004



R934007





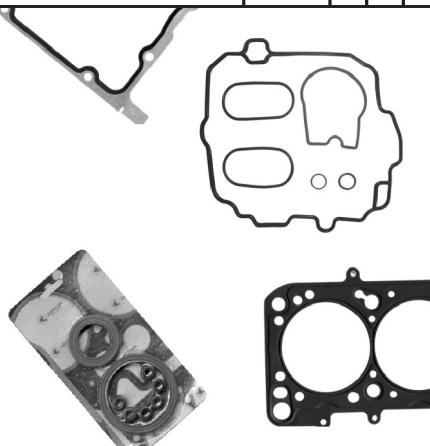

Juntalima
Indústria e Comércio de Auto Peças Ltda



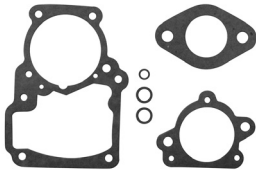

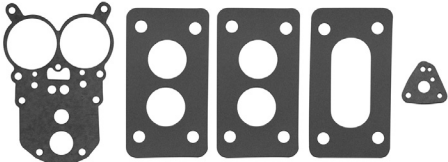
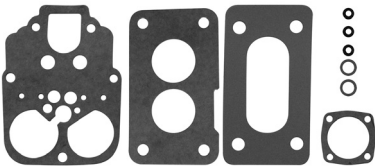
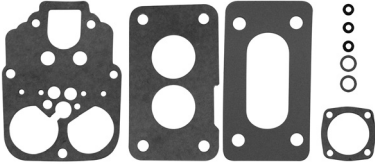
- Juntas mls
- Juntas Metal-Elastômeto
- Juntas em Borracha
- Cortiças
- Retentores

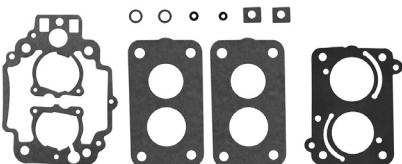
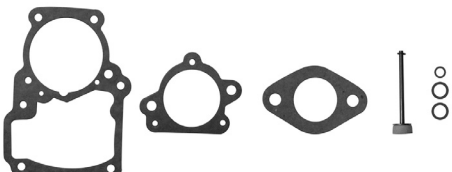



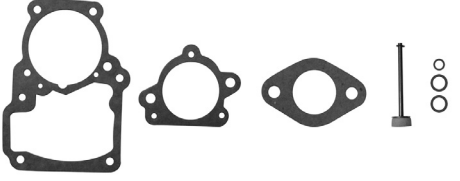
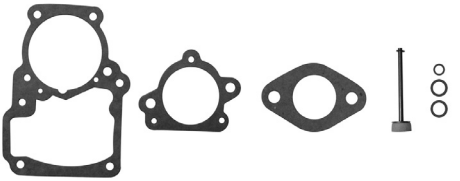
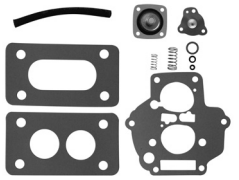

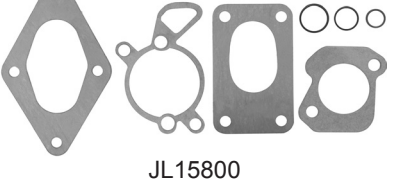
Junta	Aplicação	Veículo / Motor
 <p>JL11162</p>	Jogo de juntas para carburador	Corcel 1.4/1.6 Weber
 <p>JL11247</p>	Junta base carburador	Corcel Todos (A)
 <p>JL11350</p>	Jogo de juntas para carburador	Corcel II/Belina II/Del Rey 1.6 Weber
 <p>JL11850</p>	Jogo de juntas para carburador	Escort/Del Rey 1.6 Weber
 <p>JL11850A</p>	Jogo de juntas para carburador	Corcel 1.6 Weber Mini progressivo
 <p>JL11860</p>	Jogo de juntas para carburador	Escort CHT 86 Solex duplo
 <p>JL11870</p>	Jogo de juntas para carburador	Escort XR3/Del Rey TLDZ
 <p>JL11162K</p>	Kit de reparos para carburador	Escort CHT 86 (álcool/gasolina) Solex 130.007

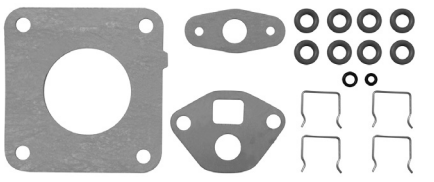

Junta	Aplicação	Veículo / Motor
 <p>JL11162KA</p>	Kit de reparos para carburador	Corcel II Weber 401.409 DFV-Simpl.Alc.
 <p>JL11162KG</p>	Kit de reparos para carburador	Corcel II Weber 400.887 DFV-Simpl Gasolina
 <p>JL11850K</p>	Kit de reparos para carburador	Ford CHT Duplo (álcool/gasolina) 401.73302
 <p>JL11860K</p>	Kit de reparos para carburador	Escort CHT 86 (álcool/gasolina) Solex 130.007
 <p>JL15800</p>	Jogo de juntas para injeção eletrônica	Versales Royale Singlepoint (Anel viton)
 <p>JL15801</p>	Jogo de juntas para injeção eletrônica	Verona/XR3/Versales 2.0 Multipoint (anel viton)
 <p>JL15802</p>	Jogo de juntas para injeção eletrônica	Fiesta 1.3 Singlepoint (anel viton)
 <p>JL15806</p>	Jogo de juntas para injeção eletrônica	Ranger 4cc 2.3/2.5 Multipoint

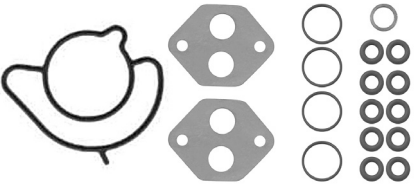
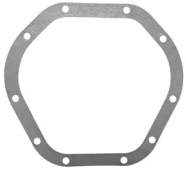
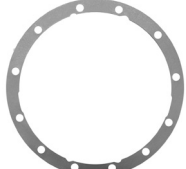
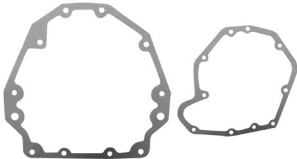

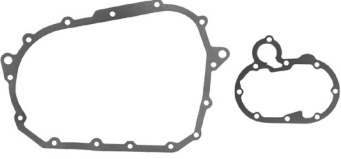
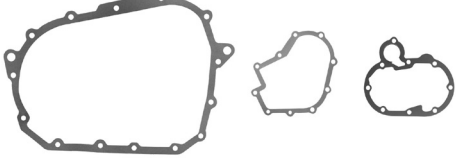
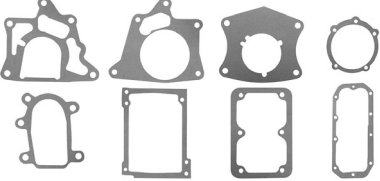
Junta	Aplicação	Veículo / Motor
 <p>JL15807</p>	Jogo de juntas para injeção eletrônica	Fiesta/Ka 1.0/1.3 Multipoint (anel viton)
 <p>JL11457</p>	Junta do diferencial	C14/F100/F1000 4 marcas antigas
 <p>JL11931</p>	Junta do diferencial	F350
 <p>JL11191</p>	Jogo de juntas para câmbio	Corcel todos 4 marchas
 <p>JL11481</p>	Jogo de juntas para câmbio	Corcel II/Del Rey 5 marchas
 <p>JL11880</p>	Jogo de juntas para câmbio	Escort 4 marchas
 <p>JL11881</p>	Jogo de juntas para câmbio	Escort 5 marchas
 <p>JL13680</p>	Jogo de juntas para câmbio com reduzida	Jeep/Willys/Pick Up