



MERCEDES
CATÁLOGO LINHA LEVE
EDIÇÃO 15 ANO 2017

Mercedes-Benz



Juntalima

Motor/Engine 1.6 8V MB 166.960

1.6 8V MB 166.961

Códigos jogos de juntas

Code set gaskets

Kit retificação com retentores

016305KR

Kit retificação sem retentores

016305K

Head set with oil seals

016305KR

Head set without oil seals

016305K

Modelo / Model Cm³ De Até

Classe A 160 (Brasil) 1598 1997

Classe A 140 1598 2001 2004

Vaneo 1598 2001



JL016305

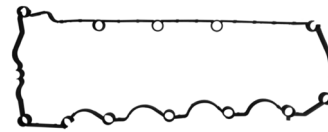

JL016427



JL016323



JL016324

Código/Code	N° Original	Aplicação / application	MP	C	K	M
016305		Cabeçote / cylinder head gasket	PAK		1	
016427		Tampa de válvulas / rocker cover gasket	BO		1	
016323		Coletor de escapamento / exhaust manifold	CNAC		1	
016324		Coletor de admissão / intake manifold	BO		4	
016085		Guarnição	MLS		1	
016084		Guarnição	MLS		1	
25038		Arruela 12x16x1,5	AL		1	
016088		Válvula termostática / thermostatic valve	BO		1	
016089		Corpo da borboleta	BO		1	
KB		Kit de borrachas / kit rubbers	BO		9	
R830001		Kit de retentores com flange				
R831001		Retentores de haste de válvulas 5x8,5x9,5	VI		4	
R831002		Retentores de haste de válvulas 6x9,5x8,5	VI		4	
R934001		Retentor dianteiro 40x62x8	BO		1	



JL016085



JL016084



JL25038



JL016088



JL016089

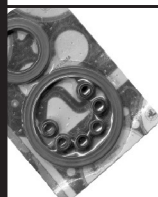
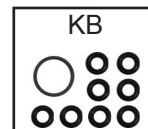

Juntalima
Indústria e Comércio de Auto Peças Ltda

CONHEÇA NOSSA LINHA DE RETENTORES

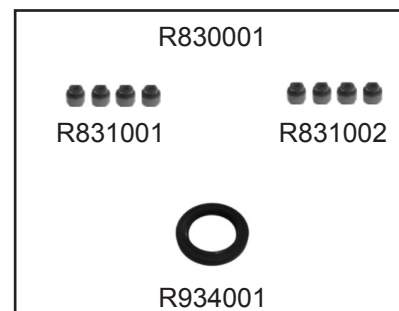

Mercedes-Benz



Juntalima

Motor/Engine 1.9 8V MB 166.990
1.9 8V MB 166.991

Códigos jogos de juntas
Code set gaskets

Kit retificação com retentores
016307KR
Kit retificação sem retentores
016307K

Head set with oil seals
016307KR
Head set without oil seals
016307K

Modelo / Model Cm³ De Até

Classe A 190	1898	1999	
Vaneo	1898	2001	



JL016307

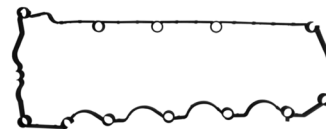

JL016427



JL016323



JL016325



JL016085



JL016084



JL25038



JL016089

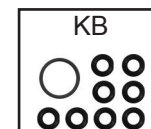

Código/Code	Nº Original	Aplicação / application	MP	C	K	M
016307		Cabeçote / cylinder head gasket	PAK		1	
016427		Cabeçote / cylinder head gasket	BO		1	
016323		Coletor de escapamento / exhaust manifold	CNAC		1	
016325		Coletor de admissão / intake manifold	BO		4	
016085		Guarnição	MLS		1	
016084		Guarnição	MLS		1	
25038		Arruela 12x16x1,5	AL		1	
016089		Corpo da borboleta	BO		1	
KB		Kit de borrachas / kit rubbers	BO		9	
R830001		Kit de retentores com flange				
R831001		Retentores de haste de válvulas 5x8,5x9,5	VI		4	
R831002		Retentores de haste de válvulas 6x9,5x8,5	VI		4	
R934001		Retentor dianteiro 40x62x8	PTFE		1	

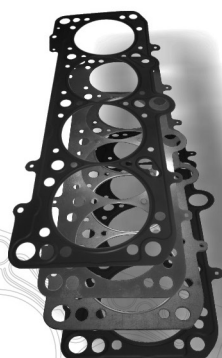

Juntalima
Indústria e Comércio de Auto Peças Ltda

**REFERÊNCIA NACIONAL
EM JUNTAS MLS**

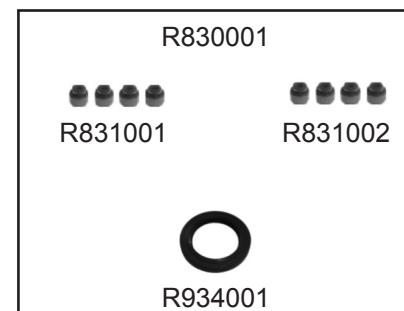



Motor/Engine 2.2 16V CDI MB 611.980
 2.2 16V CDI MB 611.981
 2.2 16V CDI MB 611.987

Códigos jogos de juntas
 Code set gaskets

Completo com retentores 016308CR	Full set with oil seals 016308CR
Completo sem retentores 016308C	Full set without oil seals 016308C
Completo c/ retentores s/ cabeçote 016308SCR	Full set w/o head gasket with oil seals 016308SCR
Completo sem cabeçote 016308SC	Full set without cyl. head gasket 016308SC
Completo MLS com retentores 016308KR	Full set MLS with oil seals 016308KR
Completo MLS sem retentores 016308K	Full set MLS without oil seals 016308K
Kit sem cabeçote com retentores 016308KSCR	Head set w/o head gasket with seals 016308KSCR
Kit retificação sem cabeçote 016308KSC	Head set without cyl. head gasket 016308KSC

Modelo / Model	Cm³	De	Até
Sprinter 311	2151	1999	
Sprinter 312	2151	1999	
Sprinter 313	2151	1999	
Sprinter 412	2151	1999	
Sprinter 413	2151	1999	

Código/Code	N° Original	Aplicação / application	MP	C	K	M
016308		Cabeçote / cylinder head gasket	PAK	1	1	
016528		Tampa de válvulas / rocker cover gasket	BO	1	1	
016433		Coletor de admissão / intake manifold	BO	1	1	
016531		Coletor de admissão / intake manifold	PAK	1	1	
016532		Coletor de escapamento / exhaust manifold	CNAC	1	1	
016516MLS		Cárter / oil pan	MLS	1		
016533		Bomba d'água / water pump	NA	1	1	
393152		Guarnição	NA	1	1	
48168		Kit de borrachas / kit rubbers	BO	1	1	
48168B		Retorno do óleo	BO	1	1	
R830002		Kit de retentores		1	1	
R831002		Retentores de haste de válvulas 6x9,5x8,5	VI	16	16	
R834001		Retentor dianteiro 45x67x8	SI	1		
R832001		Flange	PTFE	1		

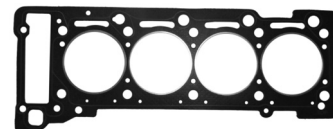

JL016308

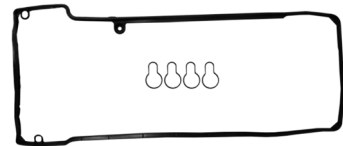

JL016528



JL016433



JL016531



JL016532

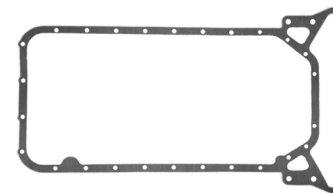

JL016516MLS



JL016533



JL393152



JL48168B

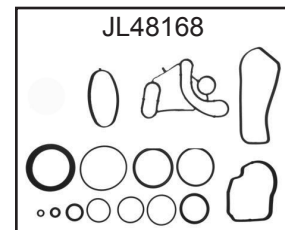

JL48168

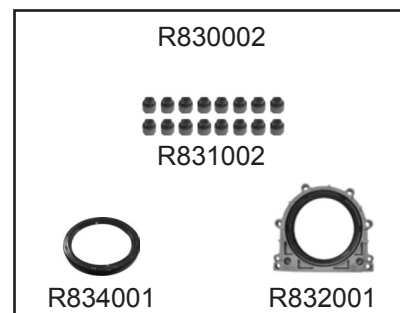

R830002

R831002

R834001

R832001



Juntalima
 Indústria e Comércio de Auto Peças Ltda

- Juntas mls
- Juntas Metal-Elastômeto
- Juntas em Borracha
- Cortiças
- Retentores

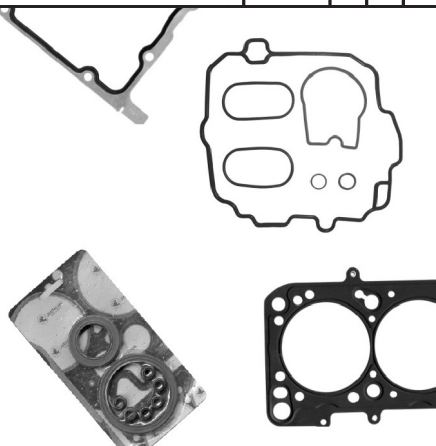



Motor/Engine 2.2 16V CDI OM 651

Códigos jogos de juntas
Code set gaskets

Modelo / Model	Cm³	De	Até	Completo com retentores 016300CR	Full set with oil seals 016300CR
Sprinter CDI				Completo sem retentores 016300C	Full set without oil seals 016300C
				Completo MLS com retentores 016300CMR	Full set MLS with oil seals 016300CMR
				Completo MLS sem retentores 016300CM	Full set MLS without oil seals 016300CM
				Kit retificação com retentores 016300KR	Head set with oil seals 016300KR
				Kit retificação sem retentores 016300K	Head set without oil seals 016300K
				Kit retificação MLS com retentores 016300KMR	MLS Head set with oil seals 016300KMR
				Kit retificação MLS sem retentores 016300KM	MLS Head set without oil seals 016300KM

Código/Code	Nº Original	Aplicação / application	MP	C	K	M
016300		Cabeçote / cylinder head gasket	PAK	1	1	
016300MLS		Cabeçote / cylinder head gasket	MLS			1
016527		Tampa de válvulas / rocker cover gasket	BO	1	1	1
016234		Coletor de admissão / intake manifold	BO	1	1	1
016334		Coletor de escapamento / exhaust manifold	CNAC	1	1	1
016634		Bomba d'água	NA	1		1
016635		Guarnição	NA	1		1
016638		Guarnição	NA	1		1
016639		Guarnição	NA	1		1
016640		Guarnição	NA	1		1
016641		Guarnição	NA	1		1
016642		Guarnição	NA	1		1
016643		Guarnição	NA	1		1
016644		Guarnição	NA	1		1
016645		Guarnição	NA	1		1
016647		Guarnição	NA	1		1
016646		Guarnição	NA	1		1
KB063		Kit de borrachas / Kit rubbers	KT	1	1	1
KA019		Kit de arruelas	KT	1	1	1
R960011		Kit de retentores para motor completo				
R961007		Retentores de haste de válvulas 6x9x10	VI	16	16	16
R963009		Retentor traseiro do virabrequim 114x96x9	SI	1		1
R964012		Retentor dianteiro / comando 60x75x7	SI	1		1

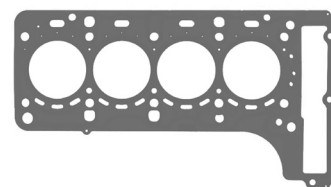

JL016300

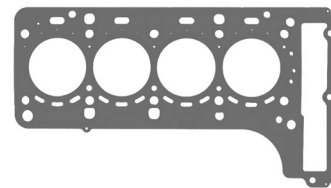

JL016300MLS

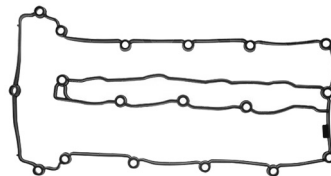

JL016527



JL016234



JL016334



JL016634 JL016635 JL016638 JL016639



JL016640 JL016641 JL016642 JL016643



JL016644 JL016645 JL016647

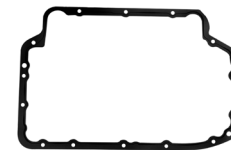

JL016646

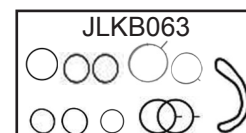

JLKB063

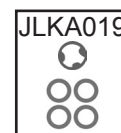

JLKA019

R960011



R961007



R963009



R964012

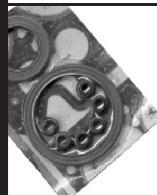

Juntalima

Indústria e Comércio de Auto Peças Ltda

**CONHEÇA NOSSA LINHA
DE RETENTORES**





Junta

Aplicação

Veículo / Motor

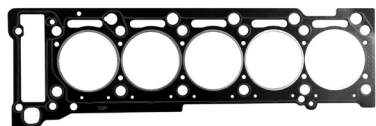

JL48100-1

Cabeçote/ cylinder head gasket

Sprinter CDI
Motor 2.7 20V MB612.962/ MB612.981
Pico 1,4mm
N. O. 05080081AB

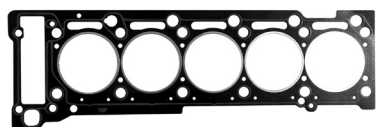

JL48100-2

Cabeçote/ cylinder head gasket

Sprinter CDI
Motor 2.7 20V MB612.962/ MB612.981
Pico 1,6mm
N. O. 05080081AA