



mitsubishi
CATÁLOGO LINHA LEVE
EDIÇÃO 15 ANO 2017

Mitsubishi



Juntalima

Motor/Engine 1.8 16V 4G93
2.0 16V 4G64

Códigos jogos de juntas
Code set gaskets

Modelo / Model Cm³ De Até

Pajero IO	1799	1998	
Montero IO	1999	2001	
Pajero IO	1999	2001	
Pajero TR4 Flex	1999	2002	

Completo com retentores
54101CR
Completo sem retentores
54101C
Completo MLS com retentores
54101CMR
Completo MLS sem retentores
54101CM
Kit retificação com retentores
54101KR
Kit retificação sem retentores
54101K
Kit retificação MLS com retentores
54101KMR
Kit retificação MLS sem retentores
54101KM

Full set with oil seals
54101CR
Full set without oil seals
54101C
Full set MLS with oil seals
54101CMR
Full set MLS without oil seals
54101CM
Head set with oil seals
54101KR
Head set without oil seals
54101K
MLS Head set with oil seals
54101KMR
MLS Head set without oil seals
54101KM



JL54101

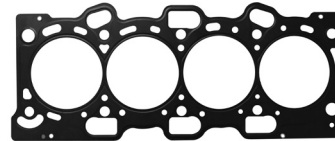

JL54101MLS

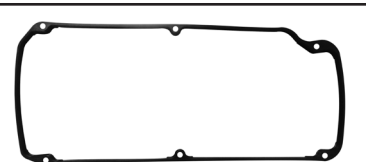

JL54126



JL54727KV

JL54126K



JL54123



JL54422



JL40838

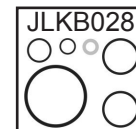

JLKB028

Código/Code	N° Original	Aplicação / application	MP	C	K	M
54101		Cabeçote / cylinder head gasket	PAK	1	1	
54101MLS		Cabeçote / cylinder head gasket	MLS			1
54126		Tampa de válvulas / rocker cover gasket	BO			
54727KV		Kit vedadores de Velas	KT			
54126K		Kit tampa de válvulas com vedadores de velas	KT	1	1	1
54123		Coletor de escapamento / exhaust manifold	CNAC	1	1	1
54422		Coletor de admissão / intake manifold	MLS	1	1	1
40838		Guarnição	NA	2	2	2
JLKB028		Kit de borrachas / kit rubbers	BO	1	1	1
R740004		Kit de retentores para motor completo				
R741004		Retentores de haste de válvulas 5,2x10,8x10	VI	16	16	16
R934004		Retentor do comando de válvulas 35x50x7	SI	1	1	1
R743003		Retentor traseiro do virabrequim 85x103x8	SI	1		
R744002		Retentor dianteiro do virabrequim 37x50x6	SI	1		



- Juntas mls
- Juntas Metal-Elastômeto
- Juntas em Borracha
- Cortiças
- Retentores

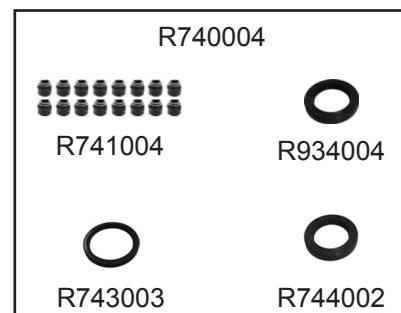
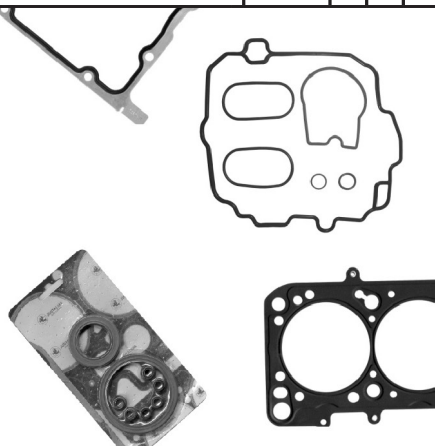



Motor/Engine 2.4 16V 4G69

Códigos jogos de juntas
Code set gaskets

Modelo / Model	Cm³	De	Até	Completo com retentores 54200CR	Full set with oil seals 54200CR
Airtrek	2378	2003	2006	Completo sem retentores 54200C	Full set without oil seals 54200C
Grandis	2378	2003		Completo MLS com retentores 54200CMR	Full set MLS with oil seals 54200CMR
Outlander	2378	2003	2006	Completo MLS sem retentores 54200CM	Full set MLS without oil seals 54200CM
Outlander LS	2378	2003	2006	Kit retificação com retentores 54200KR	Head set with oil seals 54200KR
Outlander XLS	2378	2004	2006	Kit retificação sem retentores 54200K	Head set without oil seals 54200K
Outlander Limited	2378	2004	2006	Kit retificação MLS com retentores 54200KMR	MLS Head set with oil seals 54200KMR
Galant DE	2378	2005	2006	Kit retificação MLS sem retentores 54200KM	MLS Head set without oil seals 54200KM
Galant ES	2378	2006	2008		
Galant SE	2378	2006	2009		
Outlander SE	2378	2006	2006		
Galant	2378	2006			
Galant Sport Edition	2378	2006	2009		

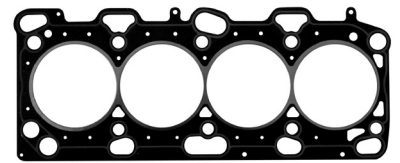

JL54200

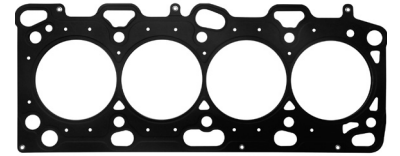

JL54200MLS

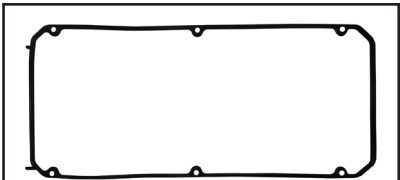

JL54026



JL54727KV

JL54026K



JL54022



JL54023



JL54090



JL54091



JL54092



JL54093



JL25018

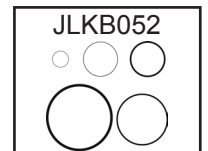

JLKB052

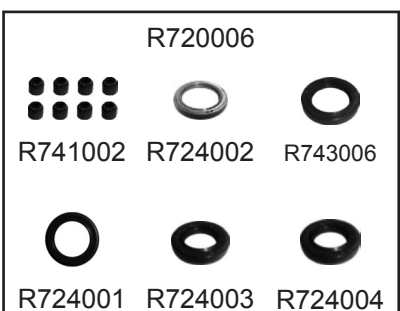

R720006

R741002

R724002

R743006

R724001

R724003

R724004

Código/Code	Nº Original	Aplicação / application	MP	C	K	M
54200		Cabeçote / cylinder head gasket	PAK	1	1	
54200MLS	10165800	Cabeçote / cylinder head gasket	MLS			1
54026		Tampa de válvulas / rocker cover gasket	BO	1	1	1
54727KV		Vedadores da tampa de válvulas	BO	4	4	4
54026K		Kit tampa de válvulas e vedadores	KIT			
54022	13202900	Coletor de admissão / intake manifold	MLS	1	1	1
54023		Coletor de escapamento / exhaust manifold	PAK	1	1	1
54090		Guarnição	NA	1		1
54091		Guarnição	NA	1		1
54092		Guarnição	NA	1		1
54093		Guarnição	NA	1		1
25018		Distribuidor d'água	AL	1		1
KB052		Kit de borrachas / kit rubbers	BO	1	1	1
R740006		Kit de retentores para motor completo				
R741002	12025000	Retentor de haste de válvulas 4,8x10,8x10,6	VI	16	16	16
R724002		Retentor do comando de válvulas 35x50x8	SI	1	1	1
R743006		Retentor traseiro do virabrequim 85x103x8	SI	2		2
R724001		Retentor dianteiro do virabrequim 44x60x7	SI	1		1
R724003		Retentor do eixo intermediário 25x35x7	BO	1		1
R724004		Retentor do eixo intermediário 17x28x7	BO	1		1

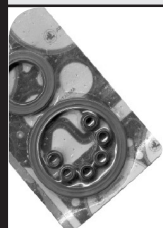

Juntalima
Indústria e Comércio de Auto Peças Ltda

**CONHEÇA NOSSA LINHA
DE RETENTORES**





Motor/Engine 2.4 8V 4D56

Códigos jogos de juntas
Code set gaskets

Modelo / Model	Cm ³	De	Até	Completo MLS com retentores 54404CMR	Full set MLS with oil seals 54404CMR
L200	2476	1987		Completo MLS sem retentores 54404CM	Full set MLS without oil seals 54404CM
Pajero	2476	1986		Completo c/ retentores s/ cabeçote 54404SCR	Full set w/o cyl. head gasket with oil seals 54404SCR
L400	2476	1996		Completo sem cabeçote 54404SC	Full set without cyl. head gasket 54404SC
L300	2476	1998		Kit retificação MLS com retentores 54404KMR	MLS Head set with oil seals 54404KMR
L300 Truck	2476	1987		Kit retificação MLS sem retentores 54404KM	MLS Head set without oil seals 54404KM
Canter T35	2476	1987	1998	Kit sem cabeçote com retentores 54404KSCR	Head set w/o head gasket with seals 54404KSCR
Montero	2476	1986		Kit retificação sem cabeçote 54404KSC	Head set without cyl. head gasket 54404KSC

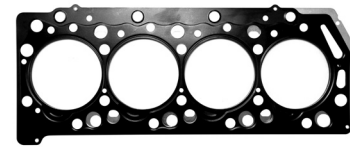

JL54110MLS

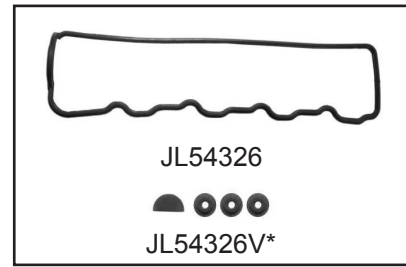

JL54326

JL54326V*

JL54326K*



JL54722MLS

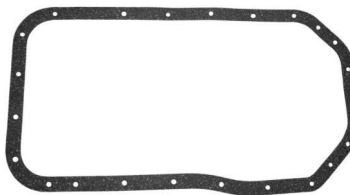

JL54815



JL54275K



JL54113



JL54198

JL54199



JL54114

JL54118



JL54119

JL54124



JL54128

JL54129



JL54134

JL54987KB

Código/Code	N° Original	Aplicação / application	MP	C	K	M
54110MLS		Cabeçote / cylinder head gasket	MLS		1	1
54326		Tampa de válvulas / rocker cover gasket	BO		1	1
54326V		Vedadores da tampa de válvulas	BO			
54326K		Kit tampa de válvulas e vedadores	KT			
54722MLS		Coletor de admissão / intake manifold	CNAC		1	1
54815		Cárter / oil pan	CB			1
54275K		Kit coletor de escapamento / exhaust manifold kit	CNAC		1	1
54198		Guarnição	CNAC			1
54199		Guarnição	NA			1
54113		Tampa da distribuição	NA			1
54114		Porta do virabrequim	NA			1
54118		Tampa da bomba d'água	NA		1	1
54119		Filtro de óleo	NA		1	1
54124		Base bomba d'água	NA			1
54128		Termostato	NA			1
54129		Tampa termostato	NA			1
54134		Vareta de óleo	NA			1
54987KB		Kit de borrachas / kit rubbers	KB			1
R720001		Kit de retentores para motor completo				
R721001		Retentores de haste de válvulas	VI		8	8
R724002		Retentor do comando de válvulas 35x50x8	SI		1	1
R723001		Retentor traseiro do virabrequim 80x96x7,5	SI			1
R724001		Retentor dianteiro do virabrequim 44x60x7	SI			1
R724003		Retentor do eixo intermediário 25x35x7	BO			1
R724004		Retentor do eixo intermediário 17x28x7	BO			1

Itens Relacionados

Juntas do Cabeçote

Kit tampa de válvulas

JL54110
Junta do cabeçote
Hyundai H100
Mitsubishi L200

JL54326K
Kit tampa de válvulas
Hyundai HR/ H100
Mitsubishi L200

Em breve novidades

Em breve novidades

Em breve novidades

R720001

R721001 R724002 R723001
R724001 R724003 R724004

*Não acompanha o jogo.
Vendido separadamente.

Mitsubishi



Juntalima

Motor/Engine 2.8 8V 4M40T TDI (SOHC)

Códigos jogos de juntas
Code set gaskets

Modelo / Model	Cm³	De	Até	Completo com retentores 54509CR	Full set with oil seals 54509CR
Pajero	2835	1996	1999	Completo sem retentores 54509C	Full set without oil seals 54509C
Montero	2835	1996	1999	Completo s/ cabeçote c/ retentores 54509SCR	Full set w/o cyl. head gasket with seals 54509SCR
Shogun	2835	1996	1999	Completo s/ cabeçote e retentores 54509SC	Full set w/o cyl. head gasket and seals 54509SC
				Kit retificação com retentores 54509KR	Head set with oil seals 54509KR
				Kit retificação sem retentores 54509K	Head set without oil seals 54509K
				Kit sem cabeçote com retentores 54509KSCR	Head set w/o head gasket with seals 54509KSCR
				Kit retificação sem cabeçote 54509KSC	Retification kit without head gasket 54509KSC

Código/Code	N° Original	Aplicação / application	MP	C	K	M
54509		Cabeçote / cylinder head gasket	PAK	1	1	
54536		Tampa de válvulas / rocker cover gasket	BO	1	1	
54536KV		Vedadores da tampa de válvulas	KT	2	2	
54536K		Kit tampa e vedadores de válvulas	KT			
54271		Coletor de escapamento / exhaust manifold	CNAC	4	4	
54274		Coletor de admissão / intake manifold	NA	4	4	
54275K		Kit coletor de escapamento / exhaust manifold kit	CNAC	1	1	
54517		Cárter / oil pan	NA	1		
54269		Guarnição	NA	1	1	
54270		Guarnição	NA	1	1	
54272		Guarnição	NA	1		
54529		Bomba d'água / water pump	BO	1	1	
54544		Guarnição	CNAC	1	1	
54545		Saída escapamento	CNAC	1	1	
54273		Filtro de óleo	NA	1	1	
KB2		Kit de arruelas e borrachas	BOAL	1	1	
KA		Kit de arruelas / kit washers	AL	1	1	
KB		Kit de borrachas / kit rubbers	BO	1	1	
R740001		Kit de retentores para motor completo				
R721001		Retentores de haste de válvulas 7x12,9x13	VI	8	8	
R744001		Retentor do comando de válvulas 50x74x11 (com aba)	SI	1		
R743001		Retentor traseiro do virabrequim 91x114x12 (com aba)	SI	1		



JL54509

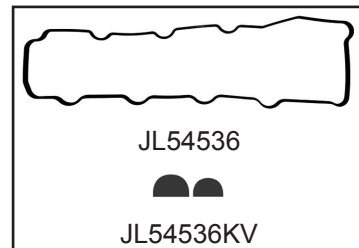

JL54536

JL54536KV

JL54536K



JL54271



JL54274



JL54275K

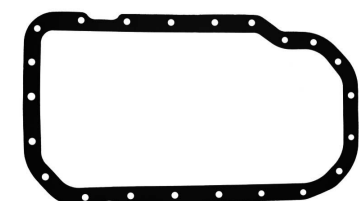

JL54517



JL54269



JL54270



JL54272



JL54529



JL54544



JL54545

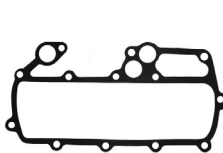

JL54273

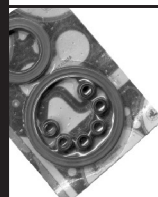
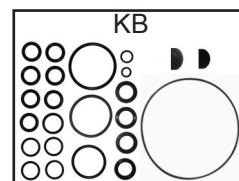

Juntalima
Indústria e Comércio de Auto Peças Ltda

CONHEÇA NOSSA LINHA
DE RETENTORES

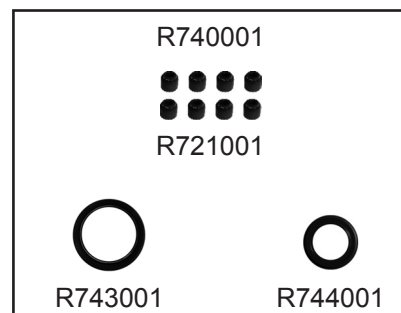

R740001

R721001

R743001

R744001



Motor/Engine 3.0 12V V6 6G72 (SOHC)

Códigos jogos de juntas
Code set gaskets

Modelo / Model	Cm*	De	Até	Completo com retentores 54309CR	Full set with oil seals 54309CR
Pajero	2972	1988	1994	Completo sem retentores 54309C	Full set without oil seals 54309C
Galant	2972	1988	1996	Kit retificação com retentores 54309KR	Head set with oil seals 54309KR
Montero	2972	1988	1996	Kit retificação sem retentores 54309K	Head set without oil seals 54309K
Shogun	2972	1988	1994		
Pick up	2972	1988	1996		
Mighty Max	2972	1989	1995		
S	2972	1989	1995		
SPX	2972	1989	1995		
Debonair	2972	1992	1995		
Sigma	2972	1988	1996		
Diamante	2972	1992	1995		

Código/Code	N° Original	Aplicação / application	MP	C	K	M
54309		Cabeçote / cylinder head gasket	PAK	2	2	
54527		Tampa de válvulas com vedador de velas	BO	2	2	
016446K		Vedadores da tampa de válvulas	BO	4	4	
54527K*		Kit tampa de válvulas com vedadores de prisioneiro	KT			
54235		Coletor de escapamento / exhaust manifold	CNAC	2	2	
54238		Coletor de admissão / intake manifold	PAK	2	2	
54239		Coletor / manifold	CNAC	1	1	
54240		Coletor / manifold	NA	1	1	
54242		Coletor / manifold	NA	2	2	
54241		Coletor / manifold	NA	1	1	
54315		Cárter / oil pan	CB	1		
54243		Guarnição	NA	1		
54244		Guarnição	NA	1		
54245		Guarnição	NA	1		
54246		Guarnição	NA	1	1	
54247		Guarnição	NA	1	1	
54248		Guarnição	NA	1	1	
54249		Guarnição	NA	1	1	
54250		Guarnição	NA	1		
54251		Guarnição	NA	1	1	
54252		Guarnição	NA	1	1	
54253		Guarnição	NA	1		
54254		Guarnição	NA	1	1	
54255		Guarnição	NA	2	2	
54256		Guarnição	NA	1	1	
54257		Guarnição	NA	1		
54258		Guarnição	CB	1	1	
54259		Guarnição	PAK	2	2	
54260		Guarnição	PAK	2	2	
54261		Guarnição	PAK	2	2	
54262		Guarnição	NA	1	1	
54263		Guarnição	NA	1	1	
54264		Guarnição	NA	1	1	
54265		Guarnição	NA	1		
KA		Kit de arruelas / kit washers	AL	1	1	
KB015		Kit de borrachas / kit rubbers	BO	1	1	
R740002		Kit de retentores para motor completo				
R721001		Retentores de haste de válvulas 7x12,9x13	VI	12	12	
R934004		Retentores do comando de válvulas 35x50x7	SI	2	2	
R743002		Retentor traseiro do virabrequim 91x111x9	SI	1		
R744002		Retentor dianteiro do virabrequim 37x50x6	SI	1		



JL54309

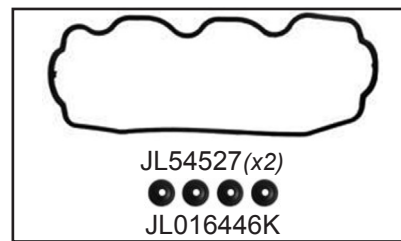

JL54527(x2)
JL016446K

JL54527K*



JL54235



JL54238



JL54239



JL54240



JL54242



JL54241



JL54315



JL54243



JL54244



JL54245



JL54246



JL54247



JL54248



JL54249



JL54250



JL54251



JL54252



JL54253



JL54254



JL54255



JL54256



JL54257



JL54258



JL54259



JL54260



JL54261



JL54262



JL54263



JL54264



JL54265



KA



JKLB015

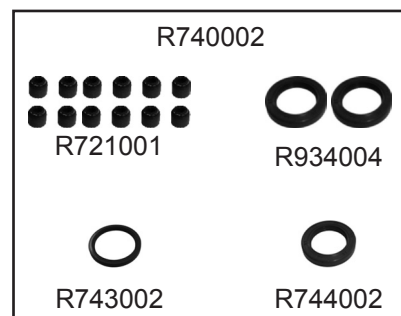

R740002



R721001



R934004



R743002



R744002

*Não Acompanha o jogo.
Vendido separadamente.

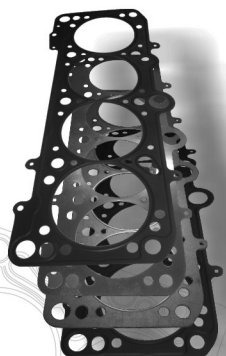

Juntalima
Indústria e Comércio de Auto Peças Ltda

REFERÊNCIA NACIONAL
EM JUNTAS MLS

Mitsubishi



Juntalima

Motor/Engine 3.0 24V V6 6G72 (SOHC)

Códigos jogos de juntas
Code set gaskets

Modelo / Model	Cm³	De	Até
Pajero	2972	2000	2001
Montero	2972	2000	2001

Completo com retentores
54609CR
Completo sem retentores
54609C

Full set with oil seals
54609CR
Full set without oil seals
54609C



JL54609(x2)

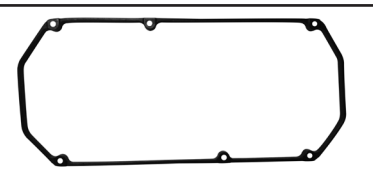

JL54727(x2)



JL54727KV

JL54727K



JL54323(x2)



JL54324MLS



JL54322(x2)



JL54138



JL54139



JL54140



JL54151



JL54160



JL54150

KB023



R740003



R741003



R934004



R741004



R743002



R744002

Código/Code	Nº Original	Aplicação / application	MP	C	K	M
54609		Cabeçote / cylinder head gasket	PAK	2		
54727K		Tampa de válvulas / rocker cover gasket	BO			
54727KV		Kit vedadores de velas	BO			
54727K		Kit tampa de válvulas com vedadores de velas	KT	1		
54323		Coletor de escapamento / exhaust manifold	MLS	2		
54324MLS		Coletor de admissão / intake manifold	MLS	1		
54322		Coletor de escapamento / exhaust manifold	CNAC	2		
54138		Guarnição	MLS	1		
54139		Guarnição	MLS	1		
54140		Guarnição	MLS	1		
54151		Guarnição	MLS	1		
54160		Guarnição	MLS	1		
54150		Guarnição	MLS	1		
KB023		Kit de borrachas / kit rubbers	BO	1		
R740003		Kit de retentores para motor completo				
R741003		Retentores de haste de válvulas 5x10,8x10	VI	12		
R741004		Retentores de haste de válvulas 5,2x10,8x10	VI	12		
R934004		Retentor do comando de válvulas 35x50x7	SI	2		
R743002		Retentor traseiro do virabrequim 91x111x9	SI	1		
R744002		Retentor dianteiro do virabrequim 37x50x6	SI	1		



Juntalima
Indústria e Comércio de Auto Peças Ltda

- Juntas mls
- Juntas Metal-Elastômeto
- Juntas em Borracha
- Cortiças
- Retentores

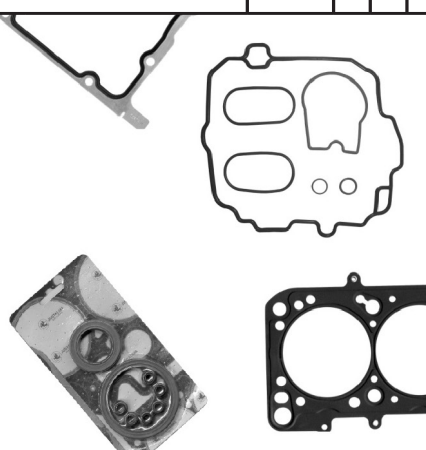

Mitsubishi



Juntalima

Motor/Engine 3.2 16V 4M41

Códigos jogos de juntas
Code set gaskets

Modelo / Model	Cm³	De	Até	Completo com retentores 54100CR	Full set with oil seals 54100CR
Pajero TD (Triton)	3200	2001		Completo sem retentores 54100C	Full set without oil seals 54100C
Montero III TD	3200	2000		Completo c/ retentores s/ cabeçote 54100SCR	Full set w/o head gasket with oil seals 54100SCR
				Completo sem cabeçote 54100SC	Full set without cyl. head gasket 54100SC
				Completo MLS com retentores 54100KR	Full set MLS with oil seals 54100KR
				Completo MLS sem retentores 54100K	Full set MLS without oil seals 54100K
				Kit sem cabeçote com retentores 54100KSCR	Head set w/o head gasket with seals 54100KSCR
				Kit retificação sem cabeçote 54100KSC	Head set without cyl. head gasket 54100KSC



JL54100

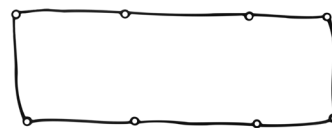

JL016026



JL54222



JL54223



JL54275K

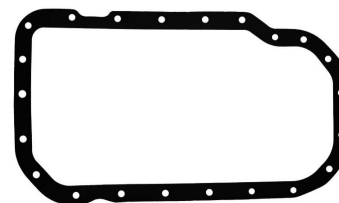

JL54517



JL54230



JL54545



JL54231



JL016279



JL54529



JL54270



JL54273

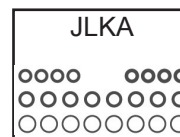

JLKA

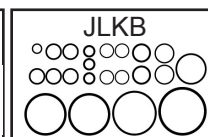

JLKB

Código/Code	N° Original	Aplicação / application	MP	C	K	M
54100	ME204037	Cabeçote / cylinder head gasket	PAK	1	1	
016026		Tampa de válvulas / rocker cover gasket	BO	1	1	
54222	ME203212	Coletor de admissão / intake manifold	BO	1	1	
54223		Coletor de escapamento / exhaust manifold	CNAC	4	4	
54275K		Kit coletor de escapamento / exhaust manifold kit	CNAC	1	1	
54517		Cárter / oil pump	NA	1		
54230		Turbina	CNAC	1	1	
54545		Saída de escapamento	CNAC	1	1	
54231		Guarnição	PV	1		
016279		Guarnição	GV	1		
54529		Bomba d'água	BO	1		
54270		Guarnição	NA	1		
54273		Filtro de óleo	NA	1	1	
JLKA		Kit de arruelas	KT	1	1	
JLKB		Kit de borrachas / kit rubbers	KT	1	1	
R740005		Kit de retentores para motor completo	KT			
R741001		Retentor de haste de válvulas 5,5x11,9x12	VI	16	16	
R743005		Retentor traseiro do virabrequim 91x114x12	VI	1	1	
R744001		Retentor dianteiro do virabrequim 50x74x11	VI	1		

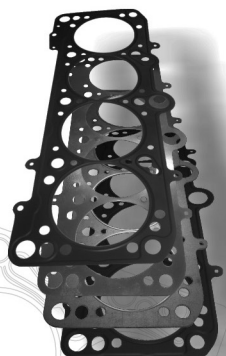





Juntalima
Indústria e Comércio de Auto Peças Ltda

**REFERÊNCIA NACIONAL
EM JUNTAS MLS**

R740005
●●●●●●●●
●●●●●●●●
R741001

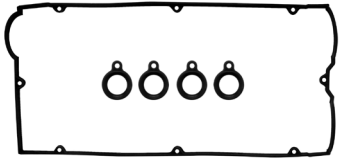
R743005 R744001



Junta	Aplicação	Veículo / Motor
 JL54226	Kit de tampa de válvulas	Lancer / Colt / Carisma 1.8 16V 4G93K 5 peças
 JL016834	Junta do coletor de escapamento	Eclipse 2.0 16V 4G63
 JL016934	Junta da saída de escapamento	Eclipse 2.0 16V 4G63
 JL016924	Junta da saída de escapamento	Eclipse 2.0 16V 4G63
 JL016922	Junta do coletor de admissão	Pajero (5 peças)