

A graphic element consisting of three white chevrons pointing to the right, outlined in red, positioned on the left side of the page.

**VOLKSWAGEN**

CATÁLOGO LINHA LEVE  
EDIÇÃO 15 ANO 2017



Motor/Engine 1.0 8V AT (SOHC) Power

Códigos jogos de juntas  
Code set gaskets

Modelo / Model	Cm³	De	Até
Gol Power	996	2002	

Completo com retentores	Full set with oil seals
<b>46501CR</b>	<b>46501CR</b>
Completo sem retentores	Full set without oil seals
<b>46501C</b>	<b>46501C</b>
Completo MLS com retentores	Full set MLS with oil seals
<b>46501CMR</b>	<b>46501CMR</b>
Completo MLS sem retentores	Full set MLS without oil seals
<b>46501CM</b>	<b>46501CM</b>
Kit retificação com retentores	Head set with oil seals
<b>46501KR</b>	<b>46501KR</b>
Kit retificação sem retentores	Head set without oil seals
<b>46501K</b>	<b>46501K</b>
Kit retificação MLS com retentores	MLS Head set with oil seals
<b>46501KMR</b>	<b>46501KMR</b>
Kit retificação MLS sem retentores	MLS Head set without oil seals
<b>46501KM</b>	<b>46501KM</b>

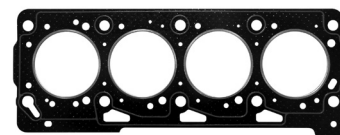

JL46901G

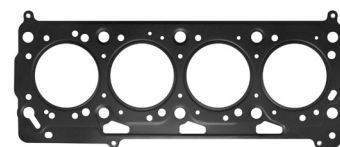

JL46802MLS



JL46127



JL46422



JL46321

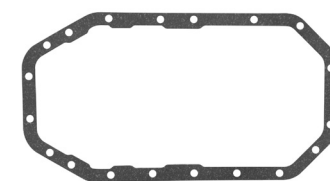

JL46916



JL46421



JL46757MLS



JL46426MLS



JL46432



JL46567



JL46247

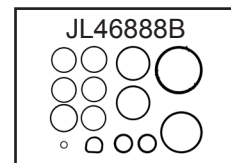

JL46888B

Código/Code	Nº Original	Aplicação / application	MP	C	K	M
46901G	036/103383/M	Cabeçote / cylinder head gasket	PAK	1		
46802MLS	036/103383/M	Cabeçote / cylinder head gasket	MLS		1	1
46127		Tampa de válvulas / rocker cover gasket	PP	1	1	1
46422		Jogo de anel de admissão	BO	1	1	1
46321		Coletor de escapamento / exhaust manifold	CNAC	1	1	1
46916	036/036011	Cárter / oil pan	CB	1		1
46421	377/353.115/F	Saída do escapamento / exhaust pipe	CNAC	1	1	1
46757MLS	032/103.161/C	Tampa da bomba de óleo	MLS	1	1	1
46426MLS	036/115111	Bomba de óleo / oil pump	MLS	1		1
46432	026/103.181/B	Acoplamento do retentor	NA	1		1
46567		Vedadores da tampa de válvulas	BO	3	3	3
46247	F70Z6675/AA	Anel bujão / ring stopper 14x20	AL	1		
46888B		Kit de borrachas / kit rubbers	KB	1		1
R980006		Kit de retentores para motor completo				
R921001		Retentores de haste de válvulas	VI	8	8	8
R984002		Retentor dianteiro / comando de válvulas 32x42x10	SI	2	1	2
R982002		Retentor da flange traseira	PTFE	1		1

Itens Relacionados

Juntas para  
Cárter

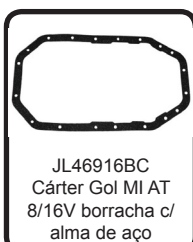

JL46916BC  
Cárter Gol MI AT  
8/16V borracha c/  
alma de aço

Juntas diversas  
MLS



JL46757MLS  
Junta bomba de óleo  
MLS Gol AT 8/16V  
Padrão original

Juntas diversas  
MLS

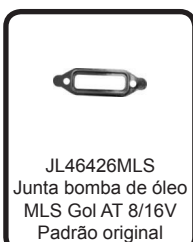

JL46426MLS  
Junta bomba de óleo  
MLS Gol AT 8/16V  
Padrão original

Kit de retentores



R980008  
Kit de retentores  
motor 1.0 8V AT  
sem flange

Em breve  
novidades

R980006



R921001



R984002



R982002



Motor/Engine 1.0 16V (SOHC) Power

Códigos jogos de juntas  
Code set gaskets

Modelo / Model	Cm³	De	Até	Completo com retentores <b>46401CR</b>	Full set with oil seals <b>46401CR</b>
Gol Power	996	2002		Completo sem retentores <b>46401C</b>	Full set without oil seals <b>46401C</b>
				Completo MLS com retentores <b>46401CMR</b>	Full set MLS with oil seals <b>46401CMR</b>
				Completo MLS sem retentores <b>46401CM</b>	Full set MLS without oil seals <b>46401CM</b>
				Kit retificação com retentores <b>46401KR</b>	Head set with oil seals <b>46401KR</b>
				Kit retificação sem retentores <b>46401K</b>	Head set without oil seals <b>46401K</b>
				Kit retificação MLS com retentores <b>46401KMR</b>	MLS Head set with oil seals <b>46401KMR</b>
				Kit retificação MLS sem retentores <b>46401KM</b>	MLS Head set without oil seals <b>46401KM</b>

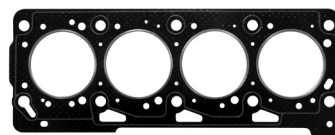

JL46901G

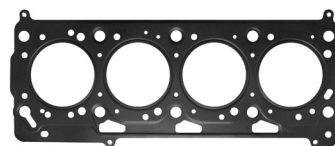

JL46802MLS



JL46127



JL46522



JL46821

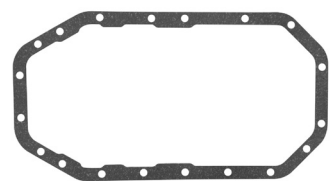

JL46916



JL46421



JL46757MLS



JL46426MLS



JL46432



JL46567

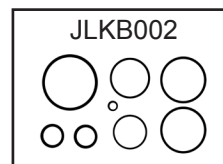

JLKB002



JL46247

Código/Code	N° Original	Aplicação / application	MP	C	K	M
46901G	036/103383/M	Cabeçote / cylinder head gasket	PAK	1		
46802MLS	036/103383/M	Cabeçote / cylinder head gasket	MLS		1	1
46127		Tampa de válvulas / rocker cover gasket	PP	1	1	1
46522		Jogo de anel de admissão	BO	1	1	1
46821	036/253039/C	Coletor de escapamento / Exhaust Manifold	CNAC	1	1	1
46916	036/036011	Cárter / oil pan	CB	1		1
46421	377/253.115/F	Saída do escapamento / exhaust pipe	CNAC	1	1	1
46757MLS	032/103.161/C	Tampa da bomba de óleo	MLS	1	1	1
46426MLS	036/115111	Bomba de óleo / oil pump	MLS	1		1
46432	026/103.181/B	Acoplamento do retentor	NA	1		1
46567		Borracha vedadora superior das válvulas	BO	3	3	3
46247	F70Z6675/AA	Anel bujão / ring stopper 14x20	AL	1		
46888B		Kit de borrachas / kit rubbers	KB	1		1
R980007		Kit de retentores para motor completo				
R911002	7581344	Retentores de haste de válvulas	VI	8	8	8
R984003	036103085A	Retentor do comando de válvulas 27x42x8	SI	2	2	2
R982002	030103171	Retentor traseiro do virabrequim flange	SI	1		1
R984002		Retentor dianteiro / comando de válvulas 32x42x10	SI	1		1

Itens Relacionados

Juntas para  
Cárter



JL46916BC  
Cárter Gol MI AT  
8/16V borracha c/  
alma de aço

Juntas diversas  
MLS

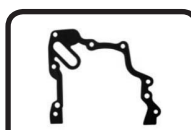

JL46757MLS  
Junta bomba de óleo  
MLS Gol AT 8/16V  
Padrão original

Juntas diversas  
MLS



JL46426MLS  
Junta bomba de óleo  
MLS Gol AT 8/16V  
Padrão original

Em breve  
novidades

Em breve  
novidades

R980007

R911002

R984003

R982002

R984002



Motor/Engine 1.0 12V CHYA/ CHYB

Códigos jogos de juntas  
Code set gaskets

Modelo / Model	Cm³	De	Até	Completo com retentores flange <b>46105CRF</b>	Full set with oil seals <b>46105CRF</b>
Up!	999	2011		Completo MLS com flange <b>46105CMRF</b>	Full set MLS with oil seals <b>46105CMRF</b>
Up! Blue Motion	999	2011		Completo com retentores <b>46105CR</b>	Full set with oil seals <b>46105CR</b>
Up! Blue Cross	999	2013		Completo sem retentores <b>46105C</b>	Full set without oil seals <b>46105C</b>
				Completo MLS com retentores <b>46105CMR</b>	Full set MLS with oil seals <b>46105CMR</b>
				Completo MLS sem retentores <b>46105CM</b>	Full set MLS without oil seals <b>46105CM</b>
				Kit retificação com retentores <b>46105KR</b>	Head set with oil seals <b>46105KR</b>
				Kit retificação sem retentores <b>46105K</b>	Head set without oil seals <b>46105K</b>
				Kit retificação MLS com retentores <b>46105KMR</b>	MLS Head set with oil seals <b>46105KMR</b>
				Kit retificação MLS sem retentores <b>46105KM</b>	MLS Head set without oil seals <b>46105KM</b>

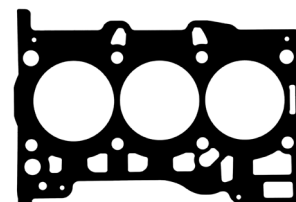

JL46105



JL46105MLS

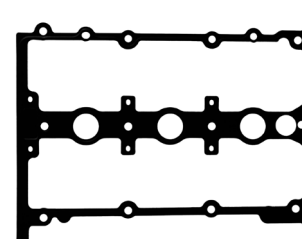

JL46236

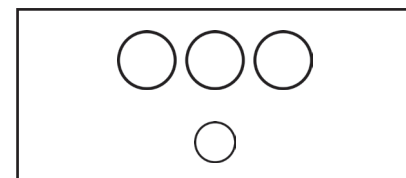

JL46031K

Código/Code	N° Original	Aplicação / application	MP	C	K	M
46105	04C103383H	Cabeçote / cylinder head gasket	PAK	1	1	
46105MLS	8433577134557	Cabeçote / cylinder head gasket	MLS			1
46236	04C1034838	Tampa de válvulas / rocker cover gasket	MLS	1	1	1
46031K	03612971E	Coletor de admissão / intake manifold	BO	1	1	1
46231	01324100	Coletor de escapamento / Exhaust Manifold	CNAC	1	1	1
46330		Guarnição	BO	1	1	1
46331		Guarnição	BO	1	1	1
46332		Guarnição	BO	1	1	1
46333		Distribuição	MLS	1		1
KB061		Kit de borrachas / Kit rubbers	KT	1	1	1
R980019		Kit de retentores para motor completo sem flange				
R980020		Kit de retentores para motor completo com flange				
R981002	11340032458	Retentores de haste de válvulas 4,25x7,4x10	VI	12	12	12
R984006	8433577124428	Retentor do comando de válvulas 36x46x7	SI	2	2	2
R982006	8433577137138	Retentor traseiro do virabrequim flange	SI	1		1
R964006	04C103085	Retentor dianteiro 30x40x7	SI	1		1
R984007		Retentor da polia 24x39x8	SI	1		1

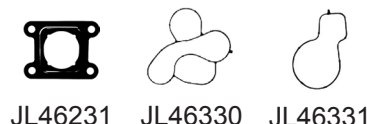

JL46231 JL46330 JL46331



JL46332 JL46333

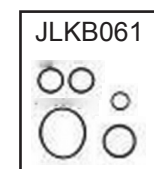

JLKB061

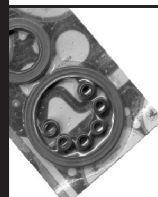

**Juntalima**  
Indústria e Comércio de Auto Peças Ltda

**CONHEÇA NOSSA LINHA  
DE RETENTORES**

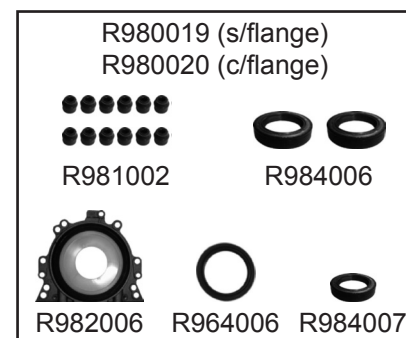

R980019 (s/flange)  
R980020 (c/flange)



R981002



R984006



R982006



R964006



R984007





Motor/Engine 1.0 8V AER/ALL/AT (SOHC)

Códigos jogos de juntas  
Code set gaskets

Modelo / Model	Cm³	De	Até	Completo com retentores <b>46909CR</b>	Full set with oil seals <b>46909CR</b>
Gol 1000	999	1995		Completo sem retentores <b>46909C</b>	Full set without oil seals <b>46909C</b>
Gol Flex	999			Completo MLS com retentores <b>46909CMR</b>	Full set MLS with oil seals <b>46909CMR</b>
				Completo MLS sem retentores <b>46909CM</b>	Full set MLS without oil seals <b>46909CM</b>
				Kit retificação com retentores <b>46909KR</b>	Head set with oil seals <b>46909KR</b>
				Kit retificação sem retentores <b>46909K</b>	Head set without oil seals <b>46909K</b>
				Kit retificação MLS com retentores <b>46909KMR</b>	MLS Head set with oil seals <b>46909KMR</b>
				Kit retificação MLS sem retentores <b>46909KM</b>	MLS Head set without oil seals <b>46909KM</b>

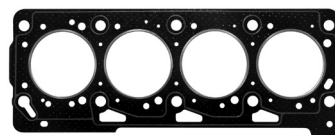

JL46901G

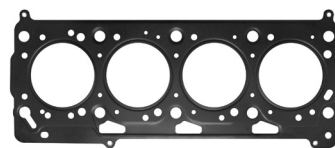

JL46802MLS



JL46526



JL46921

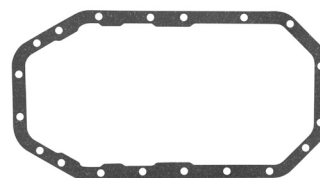

JL46916



JL46623



JL46757



JL46736



JL46432



JL46426MLS

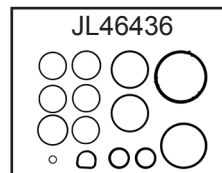

JL46436

Código/Code	N° Original	Aplicação / application	MP	C	K	M
46901G	036.103.383/M	Cabeçote / cylinder head gasket	PAK	1	1	
46802MLS	036/103.383/M	Cabeçote / cylinder head gasket	MLS		1	1
46526	030/103.483/K	Tampa de válvulas / rocker cover gasket	CHBO	1	1	1
46921	032/253.039/E	Coletor de escapamento / exhaust manifold	CNAC	1		1
46916	036/036.011	Cárter / oil pan	CB	1		1
46623	377/253.115/C	Saída do escapamento / exhaust pipe	CNAC	1	1	1
46757	032/103.161/C	Tampa da bomba de óleo	NA	1		1
46736	030/103.161/H	Tampa da bomba de óleo	NA	1		1
46432	026/103.181/B	Acoplamento do retentor	NA	1		1
46426MLS	036/115.111	Bomba de óleo / oil pump	MLS	1		1
46436		Kit de borrachas / kit rubbers	KB	1	1	1
R980005		Kit de retentores para motor completo				
R921001	7581344	Retentores de haste de válvulas	VI	8	8	8
R984001	028103085	Retentor do comando de válvulas 32x47x10	SI	1	1	1
R982001	028103171K	Retentor traseiro do virabrequim flange	SI	1		1
R984002		Retentor dianteiro do virabrequim 32x42x7	SI	1		1

Itens Relacionados

Juntas para Cárter

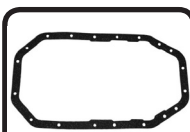

JL46916BC  
Cárter Gol MI AT  
8/16V borracha c/  
alma de aço

Juntas diversas MLS



JL46757MLS  
Junta bomba de óleo  
MLS Gol AT 8/16V  
Padrão original

Juntas diversas MLS



JL46426MLS  
Junta bomba de óleo  
MLS Gol AT 8/16V  
Padrão original

Jogo para vedadores de tampa de válvulas

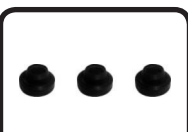

JL46567  
Jogo de vedadores  
da tampa de válvulas  
Gol Power 8/ 16V

Em breve novidades

R980005



R921001



R984001



R982001



R984002

Motor/Engine 1.0 16V AT (DOHC)

Códigos jogos de juntas  
Code set gaskets

Modelo / Model	Cm³	De	Até	Completo com retentores <b>46907CR</b>	Full set with oil seals <b>46907CR</b>
Gol 1000	999	1997		Completo sem retentores <b>46907C</b>	Full set without oil seals <b>46907C</b>
Parati	999	2002		Completo MLS com retentores <b>46907CMR</b>	Full set MLS with oil seals <b>46907CMR</b>
				Completo MLS sem retentores <b>46907CM</b>	Full set MLS without oil seals <b>46907CM</b>
				Kit retificação com retentores <b>46907KR</b>	Head set with oil seals <b>46907KR</b>
				Kit retificação sem retentores <b>46907K</b>	Head set without oil seals <b>46907K</b>
				Kit retificação MLS com retentores <b>46907KMR</b>	MLS Head set with oil seals <b>46907KMR</b>
				Kit retificação MLS sem retentores <b>46907KM</b>	MLS Head set without oil seals <b>46907KM</b>

Código/Code	Nº Original	Aplicação / application	MP	C	K	M
46901G	036/103.383/M	Cabeçote / cylinder head gasket	PAK	1	1	
46802MLS	036/103.383/M	Cabeçote / cylinder head gasket	MLS			1
46626	036/133.483/G	Tampa de válvulas / rocker cover gasket	BO	1	1	1
46326	036/103.483/D	Sobre tampa	BO	1	1	1
46821	036/253.039/C	Coletor de escapamento / exhaust manifold	CNAC	1	1	1
46916	036/036.011	Cárter / oil pan	CB	1		1
46523F	77/253.115/B	Saída do escapamento / exhaust pipe	CNAC	1	1	1
46757	032/103.161/C	Tampa da bomba de óleo	NA	1		1
46736	030/103.161/H	Tampa bomba do óleo	NA	1		1
46432	026/103.181/B	Acoplamento do retentor	NA	1		1
46426MLS	036/115.111	Bomba de óleo / oil pump	MLS	1		1
46888B		Kit de borrachas / kit rubbers	KB	1	1	1
R980002		Kit de retentores para motor completo				
R911002	7581344	Retentores de haste de válvulas	VI	16	16	16
R984001	028103085	Retentor dianteiro / comando de válvulas 32x47x10	SI	2	1	2
R982001	028103171K	Retentor traseiro do virabrequim flange	SI	1		1
R984002		Retentor dianteiro do virabrequim 32x42x7	SI	1		1

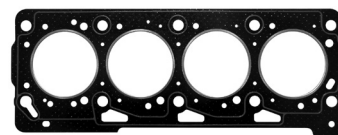

JL46901G

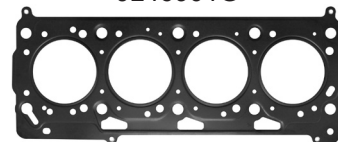

JL46802MLS



JL46626



JL46326



JL46821

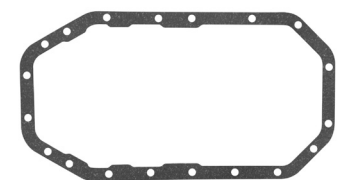

JL46916



JL46523F

JL46757



JL46736



JL46426MLS



JL46432

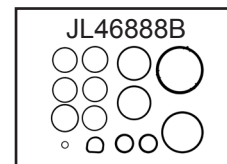

JL46888B

## Itens Relacionados

Juntas para  
Cárter

Juntas diversas

Juntas diversas

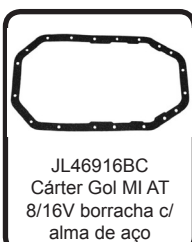
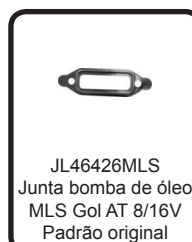
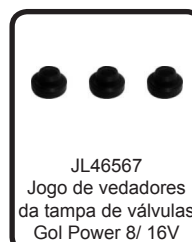
Jogo para vedadores  
de tampa de válvulasJL46916BC  
Cárter Gol MI AT  
8/16V borracha c/  
alma de açoJL46757MLS  
Junta bomba de óleo  
MLS Gol AT 8/16V  
Padrão originalJL46426MLS  
Junta bomba de óleo  
MLS Gol AT 8/16V  
Padrão originalJL46567  
Jogo de vedadores  
da tampa de válvulas  
Gol Power 8/ 16VEm breve  
novidades

R980002



R911002



R984001



R982001



R984002



Motor/Engine 1.0 8V AQZ/BJE

Códigos jogos de juntas  
Code set gaskets

Modelo / Model	Cm <sup>3</sup>	De	Até	Completo com retentores <b>46402CR</b>	Full set with oil seals <b>46402CR</b>
Fox	999	2003		Completo sem retentores <b>46402C</b>	Full set without oil seals <b>46402C</b>
Fox Total Flex	999	2003		Completo MLS com retentores <b>46402CMR</b>	Full set MLS with oil seals <b>46402CMR</b>
				Completo MLS sem retentores <b>46402CM</b>	Full set MLS without oil seals <b>46402CM</b>
				Kit retificação com retentores <b>46402KR</b>	Head set with oil seals <b>46402KR</b>
				Kit retificação sem retentores <b>46402K</b>	Head set without oil seals <b>46402K</b>
				Kit retificação MLS com retentores <b>46402KMR</b>	MLS Head set with oil seals <b>46402KMR</b>
				Kit retificação MLS sem retentores <b>46402KM</b>	MLS Head set without oil seals <b>46402KM</b>

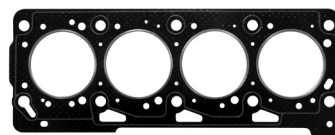

JL46901G

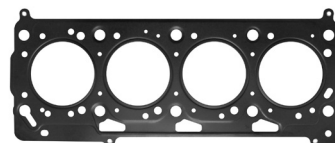

JL46802MLS



JL46127



JL46422



JL46321



JL46115

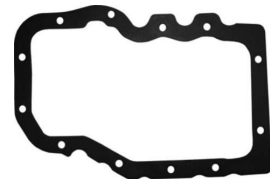

JL46415



JL46421



JL46757MLS



JL46426MLS



JL46432



JL25018



JL46829

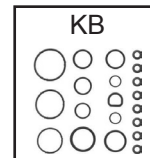

KB

Código/Code	N° Original	Aplicação / application	MP	C	K	M
46901G		Cabeçote / cylinder head gasket	PAK	1	1	
46802MLS	036/103383/M	Cabeçote / cylinder head gasket	MLS		1	1
46127		Tampa de válvulas / rocker cover gasket	PP	1	1	1
46422		Jogo de anel de admissão	BO	1	1	1
46321		Coletor de escapamento / exhaust manifold	CNAC	1	1	1
46115		Cárter / oil pan	NA	1		1
46415	036/036011	Sobre cárter	CB	1		1
46421	377/253.115/F	Saída do escapamento / exhaust pipe	CNAC	1	1	1
46757MLS	032/103.161/C	Tampa da bomba de óleo	MLS	1	1	1
46426MLS	036/115111	Bomba de óleo / oil pump	MLS	1		1
46432	026/103.181/B	Acoplamento do retentor	NA	1		1
25018		Arruela 14x20x1,5	AL	1		1
46829		Válvula taromatática	PV	1		1
KB		Kit de borrachas / kit rubbers	KB	1		1
R980008		Kit de retentores para motor (sem flange)				
R911002	036109675	Retentores de haste de válvulas	VI	8	8	8
R984002	036103085E	Retentor dianteiro / comando de válvulas 32x42x7	SI	2	1	2



**Juntalima**  
Indústria e Comércio de Auto Peças Ltda

- Juntas mls
- Juntas Metal-Elastômeto
- Juntas em Borracha
- Cortiças
- Retentores

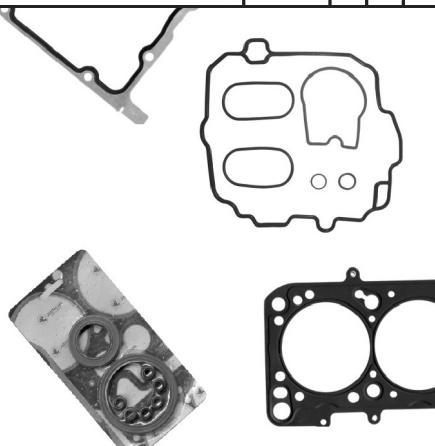

R980008

●●●●●●●●

R911002

○ ○

R984002



Motor/Engine 1.0 16V AT Turbo

Códigos jogos de juntas  
Code set gaskets

Modelo / Model	Cm³	De	Até	Completo com retentores <b>46403CR</b>	Full set with oil seals <b>46403CR</b>
Gol 1000	999	1997		Completo sem retentores <b>46403C</b>	Full set without oil seals <b>46403C</b>
Parati	999	2002		Completo MLS com retentores <b>46403CMR</b>	Full set MLS with oil seals <b>46403CMR</b>
				Completo MLS sem retentores <b>46403CM</b>	Full set MLS without oil seals <b>46403CM</b>
				Kit retificação com retentores <b>46403KR</b>	Head set with oil seals <b>46403KR</b>
				Kit retificação sem retentores <b>46403K</b>	Head set without oil seals <b>46403K</b>
				Kit retificação MLS com retentores <b>46403KMR</b>	MLS Head set with oil seals <b>46403KMR</b>
				Kit retificação MLS sem retentores <b>46403KM</b>	MLS Head set without oil seals <b>46403KM</b>

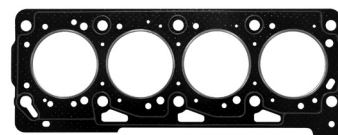

JL46901G

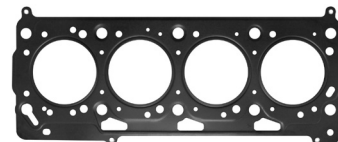

JL46802MLS



JL46626



JL46326



JL46824



JL46821

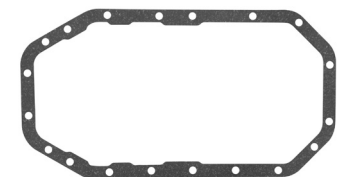

JL46916



JL46523F



JL46757MLS



JL46736



JL46426MLS



JL46432

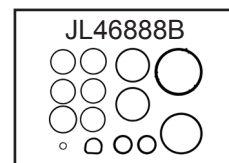

JL46888B

Código/Code	Nº Original	Aplicação / application	MP	C	K	M
46901G	036/103.383/M	Cabeçote / cylinder head gasket	PAK	1	1	
46802MLS	036/103.383/M	Cabeçote / cylinder head gasket	MLS			1
46626	036/133.483/G	Tampa de válvulas / rocker cover gasket	BO	1	1	1
46326	036/103.483/D	Sobre tampa	BO	1	1	1
46824	036/129.717/M	Coletor de admissão / intake manifold	PAK	1	1	1
46821	036/253.039/C	Coletor de escapamento / exhaust manifold	CNAC	1	1	1
46916	036/036.011	Cárter / oil pan	CB	1		1
46523F	77/253.115/B	Saída do escapamento / exhaust pipe	CNAC	1	1	1
46757MLS	032/103.161/C	Tampa da bomba de óleo	MLS	1		1
46736	030/103.161/H	Tampa da bomba do óleo	NA	1		1
46432	026/103.181/B	Acoplamento do retentor	NA	1		1
46426MLS	036/115.111	Bomba de óleo / oil pump	MLS	1		1
46888B		Kit de borrachas / kit rubbers	KB	1	1	1
R980002		Kit de retentores para motor completo				
R911002	7581344	Retentores de haste de válvulas	VI	16	16	16
R984001	028103085	Retentor dianteiro / comando de válvulas 32x47x10	SI	2	1	2
R982001	028103171K	Retentor traseiro do virabrequim flange	SI	1		1

Itens Relacionados

Juntas para Cárter

Juntas Diversas MLS

Juntas para Câmbio

Retentores

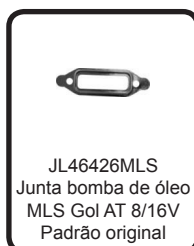
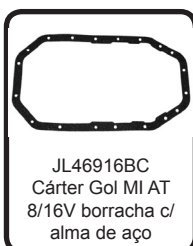

Em breve novidades

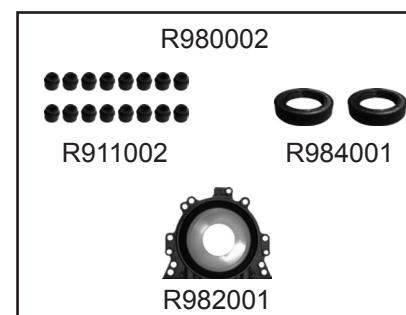





Motor/Engine VW 1300/1500/1600

Códigos jogos de juntas  
Code set gaskets

Modelo / Model	Cm³	De	Até	Completo com retentores <b>46606CR</b>	Full set with oil seals <b>46606CR</b>
Kombi	1285	1967		Completo sem retentores <b>46606C</b>	Full set without oil seals <b>46606C</b>
Variant	1285	1967			
Brasilia	1285	1967			
Fusca	1285	1967			
Kombi	1493	1967			
Variant	1493	1967			
Brasilia	1493	1967			
Fusca	1493	1967			
Kombi	1584	1967			
Fusca	1584	1967			

Código/Code	Nº Original	Aplicação / application	MP	C	K	M
46126	113.101.481	Tampa das válvulas / rocker cover	CB	2		
46621	113.251.263	Coletor de escapamento / exhaust manifold	CNAC	1		
46660	311.127.707-B	Coletor de admissão / intake manifold	GV	2		
46431	113.115.189	Cárter (peneira)	PPR	1		
46462	111.115.189	Bomba de óleo / oil pump	PP	1		
46458	113.101.419	Radiador do óleo (janelina)	FF	1		
46461	111.115.111-B	Caixa da bomba de óleo	PP	1		
46430	113.127.313	Bomba de gasolina / gasoline pump PP	PP	1		
46233	N13778-1	Base do carburador / Base carburetor	NA	1		
46432PP	311.101.341	Calço da camisa	PP	4		
46247	F70Z6675AA	Anel do bujão 14x20	FF	1		
46445	311.129.707	Arruela do tubo de admissão	AL	2		
46454	331.105.295-A	Arruela	AL	1		
25001		Arruela 6x10	AL	6		
46009		Kit papel	PP	1		
KB001		Kit de borrachas / kit rubbers	KB	1		
R984004		Retentor traseiro do virabrequim 70x90x10	NI	1		
R91135		Retentor do virabrequim				



JL46126(x2)

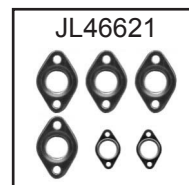

JL46660(x2)



JL46431



JL46462



JL46458



JL46461



JL46430



JL46223



JL46432PP(x4)



JL46247



JL46445(x2)



JL46454



JL25001(x6)

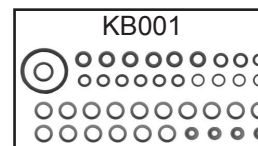
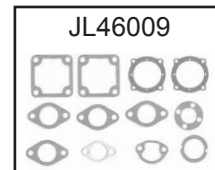

R984004

Itens Relacionados

Juntas para Carburador

JL46450  
Jogo juntas carburador VW 1300/1500

Juntas para Carburador

JL46650  
Jg juntas carburador VW Brasilia dupla

Kit de reparo para carburador

JL46450K  
Kit carburador solex 112.093  
Vw todos simples

Kit de reparo para carburador

JL46650K  
Kit carburador solex 114.093  
Vw Brasilia duplo

Juntas para Câmbio

JL46490TR  
Jg junta câmbio 1300/1500/1600 c/ anel, trava e retentor

Juntas para Saída de Escapamento

JL46621PQ  
Junta saída escapamento VW 1300/1500 pequena

Juntas para Saída de Escapamento

JL46621GR  
Junta saída escapamento VW 1300/1500 grande

Em breve novidades

Em breve novidades

Em breve novidades





Motor/Engine 1.4 8V EA 111

Códigos jogos de juntas  
Code set gaskets

Modelo / Model	Cm³	De	Até	Completo com retentores <b>46803CR</b>	Full set with oil seals <b>46803CR</b>
Kombi Flex	1390	2003		Completo sem retentores <b>46803C</b>	Full set without oil seals <b>46803C</b>
				Completo MLS com retentores <b>46803CMR</b>	Full set MLS with oil seals <b>46803CMR</b>
				Completo MLS sem retentores <b>46803CM</b>	Full set MLS without oil seals <b>46803CM</b>
				Kit retificação com retentores <b>46803KR</b>	Head set with oil seals <b>46803KR</b>
				Kit retificação sem retentores <b>46803K</b>	Head set without oil seals <b>46803K</b>
				Kit retificação MLS com retentores <b>46803KMR</b>	MLS Head set with oil seals <b>46803KMR</b>
Kit retificação MLS sem retentores <b>46803KM</b>	MLS Head set without oil seals <b>46803KM</b>				

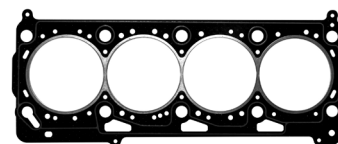

JL46005G

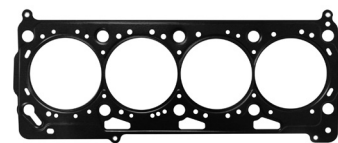

JL46005MLS



JL46127



JL46422



JL46321

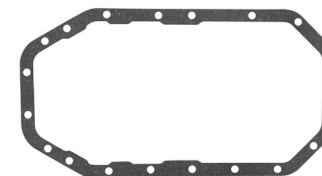

JL46916



JL46421



JL46432



JL46757MLS



JL46426MLS



JL46829



JL46247

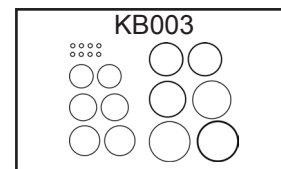

R980008



R911002



R984002

Código/Code	Nº Original	Aplicação / application	MP	C	K	M
46005MLS	032.103383.N	Cabeçote / cylinder head gasket	MLS			1
46005G		Cabeçote / cylinder head gasket	PAK	1	1	
46127		Tampa de válvulas / rocker cover gasket	PP	1	1	1
46422		Jogo de anel de admissão / kit for intake manifold	BO	1	1	1
46321	030.253039.H	Coletor de escapamento / exhaust manifold	CNAC	1	1	1
46916		Cárter / oil pan	CB	1		1
46421	155.253.115/F	Saída do escapamento / exhaust pipe	CNAC	1	1	1
46432	026.103181.B	Acoplamento da flange traseira	NA	1		1
46757MLS	032/103.161/C	Tampa da bomba de óleo	MLS	1	1	1
46426MLS	036.115111	Pescador do óleo	MLS	1		1
46829		Válvula termostática	PV	1		1
46247		Arruela do bujão	AL	1		1
KB		Kit de borrachas / kit rubbers	KB	1	1	1
R980008		Kit de retentores para motor (sem flange)				
R911002	036.109675	Retentores de haste de válvulas	VI	8	8	8
R984002		Retentor dianteiro / comando de válvulas 32x42x7	VI	2	1	2

Itens Relacionados

Juntas para  
Cárter

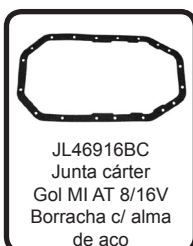

Em breve  
novidades

Em breve  
novidades

Em breve  
novidades

Em breve  
novidades



Motor/Engine 1.5 8V ZC/YJ/FL

Códigos jogos de juntas  
Code set gaskets

Modelo / Model	Cm <sup>3</sup>	De	Até	Completo com retentores <b>46706CR</b>	Full set with oil seals <b>46706CR</b>
Passat LS	1471	1974		Completo sem retentores <b>46706C</b>	Full set without oil seals <b>46706C</b>
Parati	1471	1982	1983	Kit retificação com retentores <b>46706KR</b>	Head set with oil seals <b>46706KR</b>
Voyage	1471	1982	1984	Kit retificação sem retentores <b>46706K</b>	Head set without oil seals <b>46706K</b>

Código/Code	N° Original	Aplicação / application	MP	C	K	M
46701AG	056.103.383-A	Cabeçote / cylinder head gasket	PAK	1	1	1
46726	056.103.483-A	Tampa de válvulas / rocker cover gasket	CB	1	1	
46728	056.129.717	Coletor de admissão / intake manifold	PAK	1	1	
46716	046.103.609-A	Cárter / oil pan	PAK	1		
46737F	827.253.115	Saída do escapamento / exhaust pipe	CNAC	1	1	
46721F	056.129.589	Jogo coletor do escapamento	CNAC	4	4	
46729	056.103.181	Tampa da distribuição traseira	NA	1		
46730	056.103.161	Tampa da distribuição dianteira	NA	1		
46734	056.121.041-A	Bomba d'água / water pump	GV	1		
46731	056.121.139-A	Distribuidor d'água	NA	1	1	
46735	056.115.441	Filtro superior do óleo	NA	1		
46732	056.129.799	Carburador / carburetor	NA	1	1	
46759		Base carburador	PV	1		
46799		Filtro da bomba de óleo	PP	1		
46733PP	026.121.041-M	Bomba d'água / water pump	PP	2		
016489	056.905.261	Base do distribuidor	NA	2	2	
46768		Anel do cebolão do radiador	NA	1		
46247	F70Z6675/AA	Anel do bujão 14x20	FF	1		
25011		Arruela 10x14x1	AL	1	1	
46474B		Kit de borrachas / kit rubbers	KB	1		
R980002		Kit de retentores para motor completo				
R921003	7581344	Retentores de haste de válvulas 8.8x10.8x10.3	VI	8	8	8
R984001	028103085	Retentor dianteiro / comando de válvulas 32x47x10	SI	3	2	3
R953002	056103051B/D	Retentor traseiro do virabrequim 85x105x12	SI	1		1

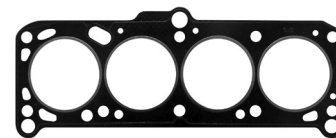

JL46701AG



JL46726



JL46728

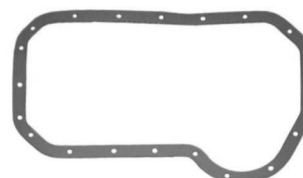

JL46716



JL46737F



JL46721F(x4)



JL46729



JL46730



JL46734



JL46731



JL46735



JL46732



JL46759



JL46799



JL46733PP



JL016489(x2)



JL46768



JL46247



JL464747B



JL25011

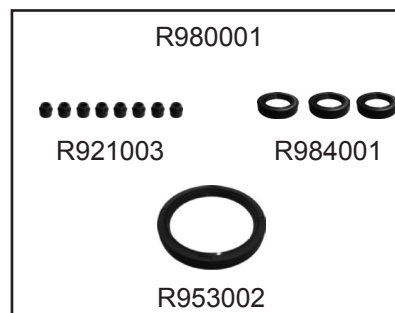

Itens Relacionados

Juntas para Carburador

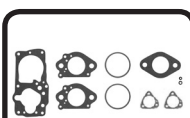

JL46750  
Jogo juntas carburador Vw Passat LS

Kit de reparo para Carburador

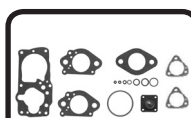

JL46750KG  
Kit carburador solex 112.093 simples Passat/Voyage gasolina

Kit de reparo para Carburador



JL46750KA  
Kit carburador solex 114.076 simples Passat/Voyage álcool

Juntas para Câmbio

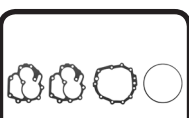

JL46780  
Jg juntas para câmbio Passat TS/LS 4 marchas

Juntas para Câmbio

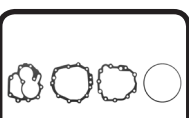

JL46780A  
Jg juntas para câmbio Passat/Gol/Santana c/anel 5 marchas



Motor/Engine 1.6 8V BAH (Golf Brasil)

Códigos jogos de juntas  
Code set gaskets

Modelo / Model	Cm³	De	Até	Completo com retentores <b>46807CR</b>	Full set with oil seals <b>46807CR</b>
Golf	1599	2002		Completo sem retentores <b>46807C</b>	Full set without oil seals <b>46807C</b>
				Completo MLS com retentores <b>46807CMR</b>	Full set MLS with oil seals <b>46807CMR</b>
				Completo MLS sem retentores <b>46807CM</b>	Full set MLS without oil seals <b>46807CM</b>
				Kit retificação com retentores <b>46807KR</b>	Head set with oil seals <b>46807KR</b>
				Kit retificação sem retentores <b>46807K</b>	Head set without oil seals <b>46807K</b>
				Kit retificação MLS com retentores <b>46807KMR</b>	MLS Head set with oil seals <b>46807KMR</b>
				Kit retificação MLS sem retentores <b>46807KM</b>	MLS Head set without oil seals <b>46807KM</b>

Código/Code	Nº Original	Aplicação / application	MP	C	K	M
46005MLS	032.103383.N	Cabeçote / cylinder head gasket	MLS			1
46005G		Cabeçote / cylinder head gasket	PAK	1	1	
46127		Tampa de válvulas / rocker cover gasket	PP	1	1	1
46422		Jogo do anel de admissão / kit for intake manifold	BO	1	1	1
46423		Coletor de escapamento / exhaust manifold	CNAC	1	1	1
46115		Cárter / oil pan	NA	1		1
46415	036/036011	Sobre cárter	CB	1		1
46003		Saída do escapamento / exhaust pipe	CNAC	1	1	1
46432	026.103181.B	Acoplamento da flange traseira	NA	1		
46757MLS	032/103.161/C	Tampa da bomba de óleo	MLS	1	1	1
46426MLS	036.115111	Pescador do óleo	MLS	1		1
46247		Arruela do bujão	AL	1		1
KB003		Kit de borrachas / kit rubbers	KB			
R980008		Kit de retentores para motor (sem flange)				
R911002	036109675	Retentores de haste de válvulas	VI	8	8	8
R984002	036103085E	Retentor dianteiro / comando de válvulas 32x42x7	SI	2	1	2

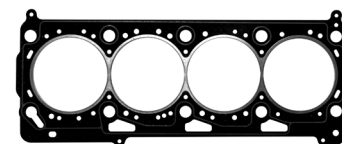

JL46005G

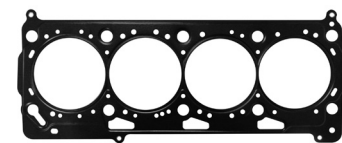

JL46005MLS



JL46127



JL46422



JL46423



JL46115

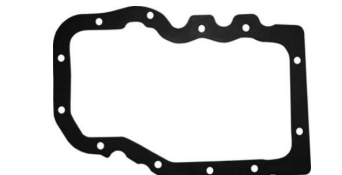

JL46432



JL46003

JL46432

JL46757MLS



JL46426MLS

JL46247

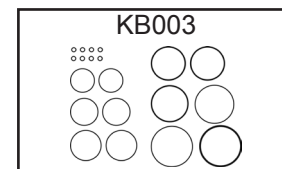

KB003

Itens Relacionados

Juntas para  
Cárter

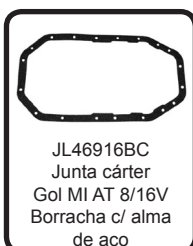

JL46916BC  
Junta cárter  
Gol MI AT 8/16V  
Borracha c/ alma  
de aço

Em breve  
novidades

Em breve  
novidades

Em breve  
novidades

Em breve  
novidades

R980008



R911002



R984002



Motor/Engine 1.6 8V BAH/BJA/BLH/EA111

Códigos jogos de juntas  
Code set gaskets

Modelo / Model	Cm <sup>o</sup>	De	Até	Completo com retentores <b>46804CR</b>	Full set with oil seals <b>46804CR</b>
Fox	1599	2003		Completo sem retentores <b>46804C</b>	Full set without oil seals <b>46804C</b>
Crossfox	1599	2006		Completo MLS com retentores <b>46804CMR</b>	Full set MLS with oil seals <b>46804CMR</b>
Spacefox	1599	2006		Completo MLS sem retentores <b>46804CM</b>	Full set MLS without oil seals <b>46804CM</b>
Polo	1599			Kit retificação com retentores <b>46804KR</b>	Head set with oil seals <b>46804KR</b>
Gol	1599			Kit retificação sem retentores <b>46804K</b>	Head set without oil seals <b>46804K</b>
				Kit retificação MLS com retentores <b>46804KMR</b>	MLS Head set with oil seals <b>46804KMR</b>
				Kit retificação MLS sem retentores <b>46804KM</b>	MLS Head set without oil seals <b>46804KM</b>

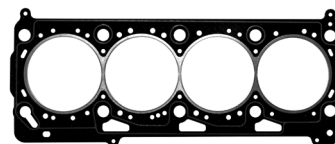

JL46005G

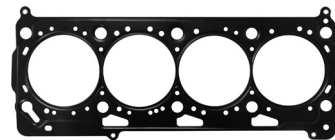

JL46005MLS



JL46127



JL46422



JL46321



JL46115

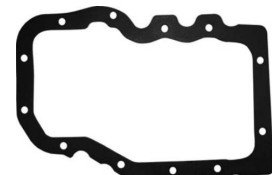

JL46415



JL46003



JL46757MLS



JL46432



JL46829



JL46426MLS



JL46247

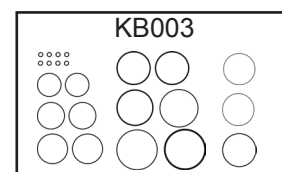

KB003

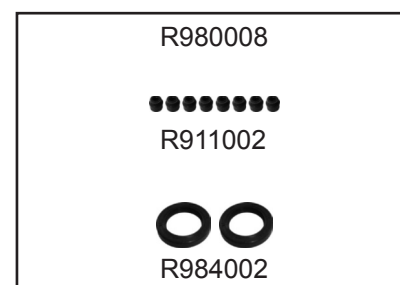

R980008

R911002

R984002

Código/Code	N° Original	Aplicação / application	MP	C	K	M
46005G	032.103383.N	Cabeçote / cylinder head gasket	PAK			1
46005MLS		Cabeçote / cylinder head gasket	MLS	1	1	
46127		Tampa de válvulas / rocker cover gasket	PP	1	1	1
46422		Jogo de anel de admissão / kit for intake manifold	BO	1	1	1
46321		Coletor de escapamento / exhaust manifold	CNAC	1	1	1
46115		Cárter / oil pan	NA	1		1
46415	036/036011	Sobre cárter	CB	1		1
46003		Saída do escapamento / exhaust pipe	CNAC	1	1	1
46757MLS	032/103.161/C	Tampa da bomba de óleo	MLS	1	1	1
46432	026.103181.B	Acoplamento da flange traseira	NA	1		1
46829		Válvula termostática	PV	1		1
46426MLS	036/115111	Pescador do óleo	MLS	1		1
46247		Arruela do bujão	AL	1	1	1
KB003		Kit de borrachas / kit rubbers	KB	1	1	1
R980008		Kit de retentores para motor (sem flange)				
R911002	036109675	Retentores de haste de válvulas	VI	8	8	8
R984002	036103085E	Retentor dianteiro / comando de válvulas 32x42x7	SI	2	1	2

Itens Relacionados

Juntas para  
Cárter

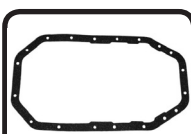

JL46916BC  
Cárter Gol MI AT  
8/16V borracha c/  
alma de aço

Em breve  
novidades

Em breve  
novidades

Em breve  
novidades

Em breve  
novidades



Motor/Engine 1.6 8V FS/FT/FR

Códigos jogos de juntas  
Code set gaskets

Modelo / Model	Cm³	De	Até	Completo com retentores <b>46709CR</b>	Full set with oil seals <b>46709CR</b>
Passat TS	1588	1983	1995	Completo sem retentores <b>46709C</b>	Full set without oil seals <b>46709C</b>
Gol	1588	1981	1995	Kit retificação com retentores <b>46709KR</b>	Head set with oil seals <b>46709KR</b>
Voyage	1588	1981	1995	Kit retificação sem retentores <b>46709K</b>	Head set without oil seals <b>46709K</b>

Código/Code	Nº Original	Aplicação / application	MP	C	K	M
46702AG	ZBA103.383-D	Cabeçote / cylinder head gasket	PAK	1	1	
46727	056.103.483-C	Tampa de válvulas / rocker cover gasket	CB	1	1	
46728	056.129.717	Coletor de admissão / intake manifold	PAK	1	1	
46716	056.103.609-A	Cárter / oil pan	PAK	1		
46767F	843.243.115	Saída do escapamento / exhaust pipe	CNAC	1	1	
46721F	056.129.589	Coletor de escapamento / exhaust manifold	CNAC	4	4	
46729	056.103.181	Tampa da distribuição traseira	NA	1		
46730	056.103.161	Tampa da distribuição dianteira	NA	1		
46734	056.121.041-A	Bomba d'água / water pump	GV	1		
46731	056.121.139-A	Distribuidor d'água	NA	1	1	
46735	056.115.441	Filtro superior do óleo	NA	1		
46732	056.121.149	Flange do cabeçote	NA	1	1	
46759	056.129.799	Flange do cabeçote	NA	1	1	
46799		Filtro da bomba de óleo	NA	1		
46733PP	026.121.041-M	Bomba d'água / water pump	PP	2		
016489	056.905.261	Base do distribuidor	NA	2		
46768		Anel do cebolão do radiador	NA	1		
46247	F70Z6675/AA	Anel do bujão 14x20	AL	1		
25011		Arruela 10x14x1,5	AL	1	1	
464747B		Kit de borrachas / kit rubbers	KB	1		
R980001		Kit de retentores para motor completo				
R921003	7581344	Retentores de haste de válvulas	VI	8	8	
R953002	056103051B/D	Retentor traseiro do vrbrequim 85x105x12	SI	1		
R984001	028103085	Retentor dianteiro / comando de válvulas 32x47x10	SI	3	2	

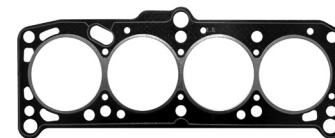

JL46702AG



JL46727



JL46728

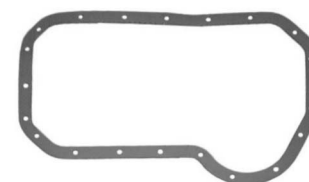

JL46716



JL46767F



JL46721F(x4)



JL46729



JL46730



JL46734



JL46731



JL46735



JL46732



JL46759



JL46799



JL46733PP(x2)



JL016489(x2)



JL46768



JL46247



JL464747B



JL25011

Itens Relacionados

Juntas para Injeção Eletrônica

JL46760  
Jg juntas carburador Vw Passat TS 1.6 Solex importado

Juntas para Carburador

JL46740  
Junta base do carburador Passat TS álcool

Kit de reparo para carburador

JL46750KG  
Kit carburador solex 112.093 simples Passat/Voyage gas.

Kit de reparo para carburador

JL46750KA  
Kit carburador solex 114.076 simples Passat/Voyage álcool

Jogo de juntas para câmbio

JL46780  
Jg de juntas câmbio Passat TS/LS 4 marchas

R921003

R984001

R953002





Motor/Engine	1.6 8V AP			
	1.8 8V AP			
Modelo / Model	Cm³	De	Até	
Gol, Voyage	1595	1985		
Santana, Passat	1595	1985		
Logus, Apollo	1595	1985		
Gol, Voyage	1781	1984		
Santana, Passat	1781	1984		
Logus, Apollo	1781	1984		
Belina, Escort	1781	1989		
Pampa, Del Rey	1781	1989		
Verona	1781	1990	1996	
Versailles	1781	1990	1996	

Códigos jogos de juntas Code set gaskets	
Completo com retentores <b>46006CR</b>	Full set with oil seals <b>46006CR</b>
Completo sem retentores <b>46006C</b>	Full set without oil seals <b>46006C</b>
Completo MLS com retentores <b>46006CMR</b>	Full set MLS with oil seals <b>46006CMR</b>
Completo MLS sem retentores <b>46006CM</b>	Full set MLS without oil seals <b>46006CM</b>
Kit retificação com retentores <b>46006KR</b>	Head set with oil seals <b>46006KR</b>
Kit retificação sem retentores <b>46006K</b>	Head set without oil seals <b>46006K</b>
Kit retificação MLS com retentores <b>46006KMR</b>	MLS Head set with oil seals <b>46006KMR</b>
Kit retificação MLS sem retentores <b>46006KM</b>	MLS Head set without oil seals <b>46006KM</b>
Completo premium com retentores <b>46006CPR</b>	Premium full set with oil seals <b>46006CPR</b>
Completo premium sem retentores <b>46006CP</b>	Premium full set without oil seals <b>46006CP</b>

Código/Code	N° Original	Aplicação / application	MP	C	K	M	P
46001AG	026.103.383	Cabeçote / cylinder head gasket	PAK	1	1		
46001MLS	026.103.383	Cabeçote / cylinder head gasket	MLS			1	1
46926	056.103.483-C	Tampa de válvulas / rocker cover gasket	CB	1	1	1	1
46022	026.129.717	Coletor de escapamento / exhaust manifold	PAK	1	1	1	1
46716	056.103.609-A	Cárter / oil pan	PAK	1		1	
46716B	056.103.609-A	Cárter padrão original / oil pan original quality	BOAL				1
46024F	843.253.115	Saída do escapamento / exhaust pipe	CNAC	1	1	1	1
46721F	056.129.589	Coletor de escapamento / exhaust manifold	CNAC	4	4	4	4
46733AL	056.121.041A	Bomba d'água padrão original metal - borracha	BOAL				1
46734	056.121.041A	Bomba d'água / water pump	GV	1		1	
46729	056.103.181	Tampa da distribuição traseira	NA	1		1	1
46730	056.103.161	Tampa da distribuição dianteira	NA	1		1	1
46731	056.121.139-A	Distribuidor d'água	NA	1	1	1	1
46735	056.115.441	Superior do Filtro de óleo / oil filter	NA	1		1	1
46732	056.121.149	Flange do cabeçote	NA	1	1	1	1
46759	056.129.799	Flange do cabeçote	NA	1		1	1
46799		Filtro da bomba de óleo	PP	1		1	1
46733PP	026.121.041M	Bomba d'água / water pump	PP	2		2	2
JL016489	056.905.261	Base do distribuidor	NA	1		1	1
46768		Anel do cebolão do radiador	NA	1		1	1
46247	F70Z6675/AA	Arruela do bujão 14x20	AL	1		1	1
25011		Arruela 10x14x1,5	AL	1		1	1
464747B		Kit de borrachas / kit rubbers	KB	1	1	1	1
R980001		Kit de retentores para motor completo					
R921003	7581344	Retentores de haste de válvulas	VI	8	8	8	8
R953002	056103051B/D	Retentor traseiro do virabrequim 85x105x12	SI	1			1
R984001	028103085	Retentor dianteiro / comando de válvulas 32x47x10	SI	3	2	3	3



JL46001AG

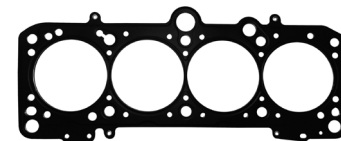

JL46003MLS

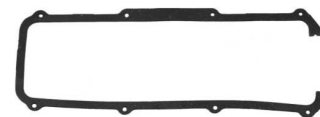

JL46926



JL46022

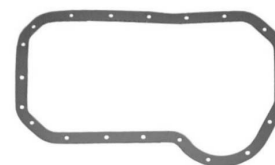

JL46716

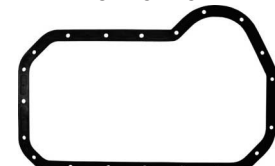

JL46716B

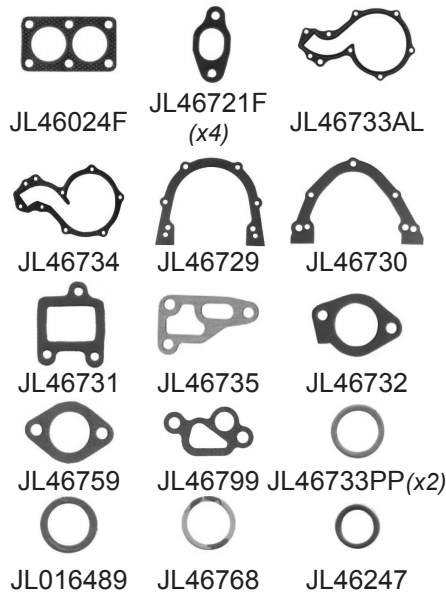

JL464747B

JL25011

Itens Relacionados

Juntas para Carburador

Juntas para Carburador

Juntas para Carburador

Juntas para Carburador

Juntas para Câmbio

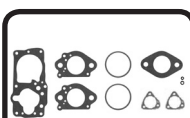

JL46050  
Jg juntas carburador  
Vw Santana 1.8  
Brosol 2-E

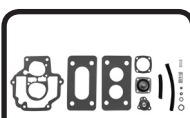

JL46051  
Jogo carburador  
Corcel II/Pampa  
Gol Ap 1600

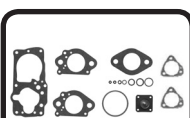

JL46750KG  
Kit carburador solex  
112.093 simples  
Passat/Voyage gas



JL46750KA  
Kit carburador solex  
114.076 simples  
Passat/Voyage  
álcool

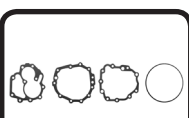

JL46780A  
Jogo junta câmbio  
Passat/Gol/Santana  
c/anel  
5 marchas

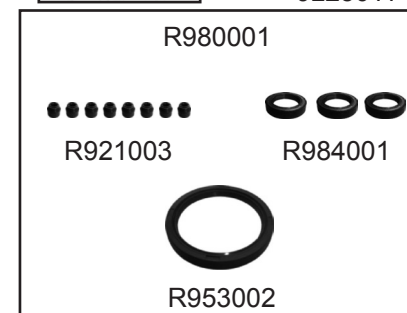



Motor/Engine 1.6/1.8 8V AP  
(Injeção Eletrônica)

Códigos jogos de juntas  
Code set gaskets

Modelo / Model	Cm³	De	Até
Parati Total Flex	1596	1998	
Saveiro Total Flex	1596	1998	
Parati	1781	1998	
Santana	1781	1998	
Saveiro	1781	1998	
Parati Total Flex	1781	1998	
Saveiro Total Flex	1781	1998	

Completo com retentores	Full set with oil seals
<b>46008CR</b>	<b>46008CR</b>
Completo sem retentores	Full set without oil seals
<b>46008C</b>	<b>46008C</b>
Completo MLS com retentores	Full set MLS with oil seals
<b>46008CMR</b>	<b>46008CMR</b>
Completo MLS sem retentores	Full set MLS without oil seals
<b>46008CM</b>	<b>46008CM</b>
Kit retificação com retentores	Head set with oil seals
<b>46008KR</b>	<b>46008KR</b>
Kit retificação sem retentores	Head set without oil seals
<b>46008K</b>	<b>46008K</b>
Kit retificação MLS com retentores	MLS Head set with oil seals
<b>46008KMR</b>	<b>46008KMR</b>
Kit retificação MLS sem retentores	MLS Head set without oil seals
<b>46008KM</b>	<b>46008KM</b>
Completo premium com retentores	Premium full set with oil seals
<b>46008CPR</b>	<b>46008CPR</b>
Completo premium sem retentores	Premium full set without oil seals
<b>46008CP</b>	<b>46008CP</b>

Código/Code	N° Original	Aplicação / application	MP	C	K	M	P
46001AG	026.103.383	Cabeçote / cylinder head gasket	PAK	1	1		
46003MLS	026.103.383	Cabeçote / cylinder head gasket	MLS			1	1
46226	026/102483/2	Tampa de válvulas / rocker cover gasket	CHBO	1	1	1	1
46728	026.129.717	Coletor de escapamento / exhaust manifold	PAK	1	1	1	1
46716	056.103.609-A	Cárter / oil pan	PAK	1		1	
46716B	056.103.609-A	Cárter Padrão Original / Oil Pan Original Quality	CHBO				1
46024F	843.253.115	Saída do escapamento / exhaust pipe	CNAC	1	1	1	1
46721F	056.129.589	Coletor de escapamento	CNAC	4	4	4	4
46732		Saída do escapamento / exhaust pipe	CNAC	1	1	1	1
46733AL	056.121.041A	Bomba d'água original metal - borracha	BOAL				1
46734	056.121.041A	Bomba d'água / water pump	GV	1		1	
46729	056.103.181	Tampa da distribuição traseira	NA	1		1	1
46730	056.103.161	Tampa da distribuição dianteira	NA	1		1	1
46731	056.121.139-A	Distribuidor d'água	NA	1	1	1	1
46735	056.115.441	Superior do Filtro de óleo / oil filter	NA	1		1	1
46732	056.121.149	Flange do cabeçote	NA	1	1	1	1
46759	056.129.799	Flange do cabeçote	NA	1		1	1
46799		Filtro da bomba de óleo	PP	1		1	1
46733PP	026.121.041M	Bomba d'água / water pump	PP	2		2	2
016489	056.905.261	Base do distribuidor	NA	1		1	1
46768		Anel do cebolão do radiador	NA	1		1	1
46247	F70Z6675/AA	Arruela do bujão 14x20	AL	1		1	1
25011		Arruela 10x14x1,5	AL	1		1	1
464747B		Kit de borrachas / kit rubbers	KB	1	1	1	1
R980001		Kit de retentores para motor completo					
R921003	7581344	Retentores de haste de válvulas	VI	8	8	8	8
R953002	056103051B/D	Retentor traseiro do virabrequim 85x105x12	SI	1		1	1
R984001	028103085/068103085	Retentor dianteiro / comando de válvulas 32x47x10	SI	3	2	3	3



JL46001AG

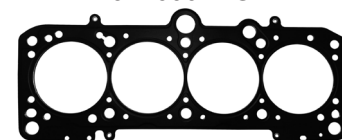

JL46003MLS



JL46226



JL46728

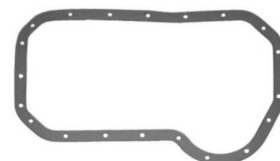

JL46716

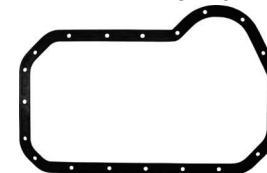

JL46716B



JL46024F



JL46721F



JL46723



JL46733AL



JL46734



JL46729



JL46730



JL46731



JL46735



JL46732



JL46759



JL46799



JL46733PP



JL016489



JL46768



JL46247

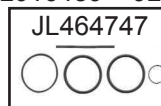

JL464747



JL25011

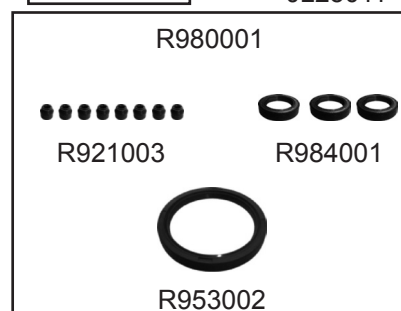

R980001



R921003



R984001



R953002

Itens Relacionados

Juntas para Injeção Eletrônica

Jogo de juntas para Câmbio

Retentores

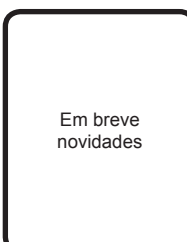
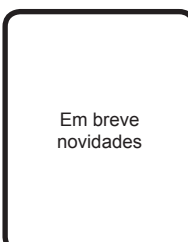



Motor/Engine 1.6 8V AKL / AHL / ANA

1.6 8V ARM / AEH / APF

Códigos jogos de juntas  
Code set gaskets

Modelo / Model Cm³ De Até

Golf	1595	1997	
Bora	1595	1998	
Polo	1595	1996	
Polo	1595	1999	
A3	1595	1996	
A4	1595	1996	

Completo com retentores  
**46905CR**  
Completo sem retentores  
**46905C**  
Completo MLS com retentores  
**46905CMR**  
Completo MLS sem retentores  
**46905CM**  
Kit retificação com retentores  
**46905KR**  
Kit retificação sem retentores  
**46905K**  
Kit retificação MLS com retentores  
**46905KMR**  
Kit retificação MLS sem retentores  
**46905KM**

Full set with oil seals  
**46905CR**  
Full set without oil seals  
**46905C**  
Full set MLS with oil seals  
**46905CMR**  
Full set MLS without oil seals  
**46905CM**  
Head set with oil seals  
**46905KR**  
Head set without oil seals  
**46905K**  
MLS Head set with oil seals  
**46905KMR**  
MLS Head set without oil seals  
**46905KM**

Código/Code	Nº Original	Aplicação / application	MP	C	K	M	P
46905G	026.103.383	Cabeçote / cylinder head gasket	PAK	1	1		
46905MLS	06A/103383/L	Cabeçote / cylinder head gasket	MLS			1	1
46226	026.103.483/2	Tampa das válvulas / rocker cover	CHBO	1	1	1	1
46221		Coletor de admissão / intake manifold	BO	4	4	4	4
46323		Coletor de admissão / intake manifold	BO	4	4	4	4
46423		Coletor de escapamento / exhaust manifold	CNAC	1	1	1	1
46521	037.253.039D	Coletor de escapamento / exhaust manifold	CNAC	1	1	1	1
46516AL		Cárter / oil pan	BOAL	1	1	1	1
11820F		Saída do escapamento / exhaust pipe	CNAC	1	1	1	1
46248MLS		Defletor de óleo	MLS	1	1	1	1
46234		Jogo de juntas do tensor da corrente	KA	1	1	1	1
46739	056.115.441	Superior do Filtro de óleo / oil filter	NA	1	1	1	1
46238	035121171/C	Tampa da distribuição / timing cover	NA	1	1	1	1
46239		Tampa da distribuição / timing cover	NA	1	1	1	1
46247	F70Z6675/AA	Arruela do bujão 14x20	AL	1	1	1	1
KB001		Kit de borrachas / kit rubbers	KT	1	1	1	1
R980009		Kit de retentores para motor completo					
R921001	7581344	Retentores de haste de válvulas	VI	8	8	8	8
R984001	028103085	Retentor do comando de válvulas 32x47x10	SI	1	1	1	1
R983004	06B103171	Retentor traseiro do virabrequim flange	PTFE	1	1	1	1
R914002		Retentor dianteiro do virabrequim 35x48x7	SI	1	1	1	1

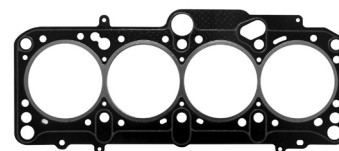

JL46905G

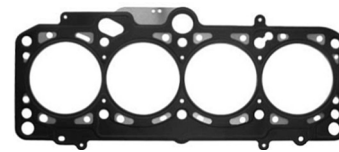

JL46905MLS



JL46226



JL46221(x4)



JL46323(x4)



JL46423



JL46521



JL46516AL



JL11820F



JL46248MLS



JL46739



JL46234



JL46238



JL46239



JL46247

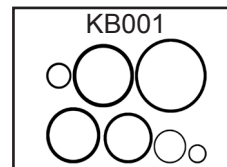

KB001

Itens Relacionados

Juntas para  
Cárter

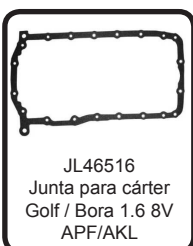

JL46516  
Junta para cárter  
Golf / Bora 1.6 8V  
APF/AKL

Em breve  
novidades

Em breve  
novidades

Em breve  
novidades

Em breve  
novidades

R980009



R921001



R984001



R983004



R914002



Motor/Engine 1.8 20V AGN

Códigos jogos de juntas  
Code set gaskets

Modelo / Model	Cm³	De	Até	Completo com retentores <b>46707CR</b>	Full set with oil seals <b>46707CR</b>
Golf	1781	1997	1999	Completo sem retentores <b>46707C</b>	Full set without oil seals <b>46707C</b>
Bora	1781	1999	2000	Completo MLS com retentores <b>46707CMR</b>	Full set MLS with oil seals <b>46707CMR</b>
				Completo MLS sem retentores <b>46707CM</b>	Full set MLS without oil seals <b>46707CM</b>
				Kit retificação com retentores <b>46707KR</b>	Head set with oil seals <b>46707KR</b>
				Kit retificação sem retentores <b>46707K</b>	Head set without oil seals <b>46707K</b>
				Kit retificação MLS com retentores <b>46707KMR</b>	MLS Head set with oil seals <b>46707KMR</b>
				Kit retificação MLS sem retentores <b>46707KM</b>	MLS Head set without oil seals <b>46008KM</b>

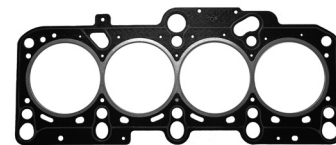

JL46004

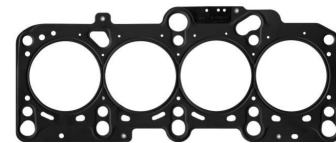

JL46004MLS

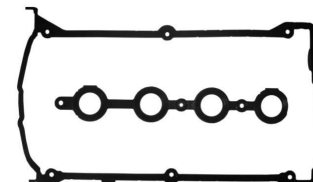

JL46027



JL46224

JL46225



JL46131MLS



JL46516AL



JL11820F JL46248MLS JL46820



JL46739

JL46234

JL46238



JL46239

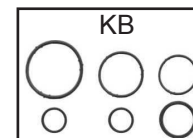

KB

Código/Code	Nº Original	Aplicação / aplicação	MP	K	M	P
46004		Cabeçote / cylinder head gasket	PAK	1		
46004MLS		Cabeçote / cylinder head gasket	MLS		1	1
46027	06A103609C	Tampa de válvulas / rocker cover gasket	CHBO	1	1	1
46224		Coletor de admissão / intake manifold	SI	2	2	2
46225		Coletor de admissão / intake manifold	SI	4	4	4
46131MLS		Coletor de escapamento / exhaust manifold	MLS	1	1	1
46516AL		Cárter / oil pan	BOAL	1	1	1
11820F		Saída do escapamento / exhaust pipe	CNAC	1	1	1
46820		Saída do escapamento / exhaust pipe	CNAC	1	1	1
46248MLS		Defletor de óleo	MLS	1	1	1
46234		Jogo de juntas do tensor da corrente	KA	1	1	1
46739	056.11.441	Superior do Filtro de óleo / oil filter	NA	1	1	1
46238	035121171/C	Tampa da distribuição / timing cover	NA	1	1	1
46239		Tampa da distribuição / timing cover	NA	1	1	1
KB		Kit de borrachas / kit rubbers	KB		1	1
R980010		Kit de retentores para motor completo com flange				
R911002	7581344	Retentores de haste de válvulas	VI	20	20	20
R914002		Retentor do comando de válvulas 35x48x7	SI	1	1	1
R982003	06A103171A	Retentor traseiro do virabrequim (flange)	PTFE		1	1
R984001	028103085/068103085	Retentor dianteiro / comando de válvulas 32x47x10	SI	1	3	3

Itens Relacionados

Juntas para Cárter

Junta para coletor de escapamento

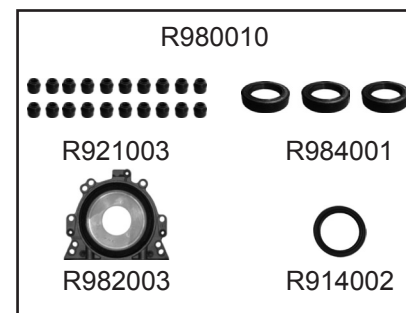
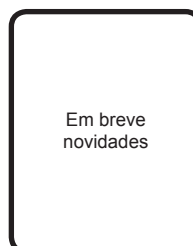
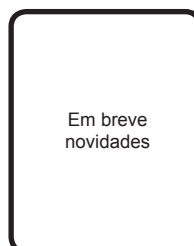
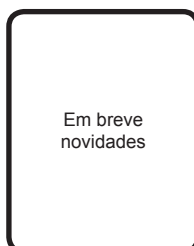
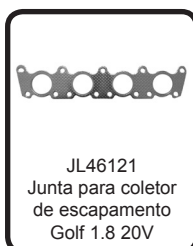
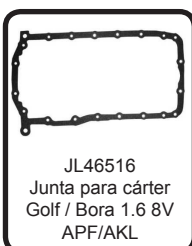





Motor/Engine 1.6/1.8 8V ADD/ADZ/AFT

Códigos jogos de juntas

Code set gaskets

Golf Importado

Modelo / Model Cm³ De Até

Golf GL/GLA	1781	1995	1998
Golf	1781	1994	1999
Polo Classic	1781	1998	2001
Passat	1781	1991	1996

Completo com retentores  
**46101CR**  
Completo sem retentores  
**46101C**  
Completo MLS com retentores  
**46101CMR**  
Completo MLS sem retentores  
**46101CM**  
Kit retificação com retentores  
**46101KR**  
Kit retificação sem retentores  
**46101K**  
Kit retificação MLS com retentores  
**46101KMR**  
Kit retificação MLS sem retentores  
**46101KM**

Full set with oil seals  
**46101CR**  
Full set without oil seals  
**46101C**  
Full set MLS with oil seals  
**46101CMR**  
Full set MLS without oil seals  
**46101CM**  
Head set with oil seals  
**46101KR**  
Head set without oil seals  
**46101K**  
MLS Head set with oil seals  
**46101KMR**  
MLS Head set without oil seals  
**46101KM**

Código/Code	N° Original	Aplicação / application	MP	C	K	M
46902G	050/103.383/A	Cabeçote / cylinder head gasket	PAK	1	1	
46003MLS		Cabeçote / cylinder head gasket	MLS			1
46226	026/103.483/2	Tampa de válvulas / rocker cover gasket	CHBO	1	1	1
46123		Coletor de admissão / intake manifold	PAK	1		1
46022		Catalizador / catalytic converter gasket	MLS		1	1
46716	056/103.690/A	Cárter / oil pan	PAK	1		1
11820F		Saída do escapamento / exhaust pipe	CNAC	1	1	1
46721F	056/129.589	Jogo coletor do escapamento / exhaust outlet	CNAC	1	1	1
46733AL	026/121.041/M	Bomba d'água / water pump	BOAL	1	1	1
46432	056/103.181	Tampa da distribuição traseira / timing cover	NA	1		1
46730	056/103.161	Tampa da distribuição dianteira / timing cover	NA	1		1
46739	056/115.441	Filtro superior do óleo / Higher oil filter	NA	1		1
46735	056/115.441	Filtro superior do óleo / Higher oil filter	NA	1		1
46247		Arruela 14x20x1,5	AL	1		1
KB		Kit de borrachas / kit rubbers	KB	1	1	1
R980014		Kit de retentores para motor completo				
R921001		Retentores de haste de válvulas	VI	8	8	8
R953002	056103051B/D	Retentor traseiro do virabrequim 85x105x12	SI	1		1
R984001	028103085/068103085	Retentor dianteiro / comando de válvulas 32x47x10	SI	3	2	3

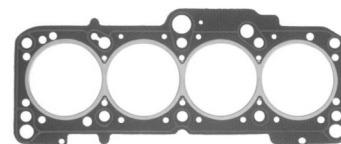

JL46902G

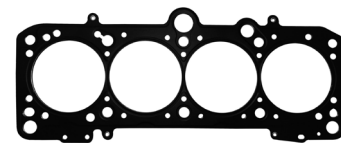

JL46003MLS



JL46226



JL46123



JL46022

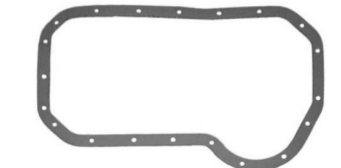

JL46716



JL11820F



JL46721F  
(x4)



JL46733AL



JL46432



JL46730



JL46739



JL46735



JL46247

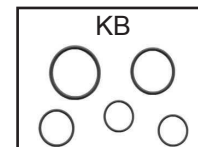

KB

Itens Relacionados

Juntas para Injeção Eletrônica

Juntas para Injeção Eletrônica

Juntas para Injeção Eletrônica

Retentores

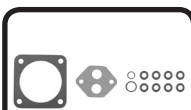

JL15904  
Jg de juntas para I.E. Golf 1.8/2.0 multipoint Importado c/ 8 anéis viton

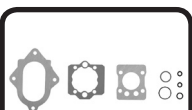

JL15905  
Jg de juntas para I.E. Golf 1.8 Pointer Singlepoint (anel viton)



JL15907  
Jg de juntas para I.E. Polo Classic 1.8 Multipoint (anel viton)



R982003  
Ret traseiro do vira com flange Passat/Santana/Golf 8mm 06A103171A



Em breve novidades

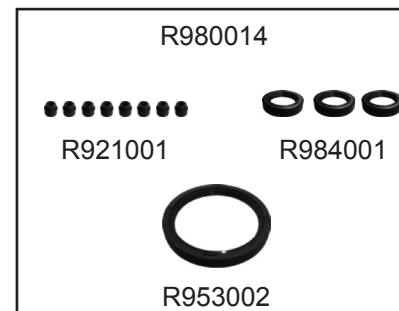

R980014

R921001

R984001

R953002





Motor/Engine 1.8 20V Turbo - AGU / AJH  
ARZ / AUM / AWU / AWT  
AUQ / APU / ARG / APT

Códigos jogos de juntas  
Code set gaskets

Completo com retentores <b>46705CR</b>	Full set with oil seals <b>46705CR</b>
Completo sem retentores <b>46705C</b>	Full set without oil seals <b>46705C</b>
Completo MLS com retentores <b>46705CMR</b>	Full set MLS with oil seals <b>46705CMR</b>
Completo MLS sem retentores <b>46705CM</b>	Full set MLS without oil seals <b>46705CM</b>
Kit retificação com retentores <b>46705KR</b>	Head set with oil seals <b>46705KR</b>
Kit retificação sem retentores <b>46705K</b>	Head set without oil seals <b>46705K</b>
Kit retificação MLS com retentores <b>46705KMR</b>	MLS Head set with oil seals <b>46705KMR</b>
Kit retificação MLS sem retentores <b>46705KM</b>	MLS Head set without oil seals <b>46705KM</b>

Modelo / Model	Cm³	De	Até
Golf Turbo	1781	1997	2003
New Beetle Turbo	1781	1996	
Sharan Turbo	1781	1999	
Bora Turbo	1781	2000	
Passat Turbo	1781	1999	
A3	1781	1998	
A3 Turbo	1781	1996	
TT Coupe	1781	1998	

Código/Code	Nº Original	Aplicação / application	MP	C	K	M
46004		Cabeçote / cylinder head gasket	PAK	1		
46004MLS		Cabeçote / cylinder head gasket	MLS		1	1
46027	06A103609C	Tampa de válvulas / rocker cover gasket	CHBO	1	1	1
46132		Coletor de admissão / intake manifold	PAK	1	1	1
46134		Coletor de admissão / intake manifold	PAK	1	1	1
46131MLS		Coletor de escapamento / exhaust manifold	MLS	1	1	1
46516AL		Cárter / oil pan	BOAL	1	1	1
11820F		Saída do escapamento / exhaust pipe	CNAC	1	1	1
46248MLS		Defletor de óleo	MLS	1	1	1
46234		Jogo de juntas do tensor da corrente	KA	1	1	1
46739	056.115.441	Superior do Filtro de óleo / oil filter	NA	1	1	1
46238	035121171/C	Distribuição	NA	1	1	1
46239		Distribuição	NA	1	1	1
KB		Kit de borrachas / kit rubbers	KB	1	1	1
R980010		Kit de retentores para motor completo com flange				
R921003	7581344	Retentores de haste de válvulas	VI	20	20	20
R914002	90180529	Retentor do comando de válvulas 35x48x7	SI	1	1	1
R982003	06A103171A	Retentor traseiro do virabrequim (flange)	PTFE	1	1	1
R984001	028103085/068103085	Retentor dianteiro / comando de válvulas 32x47x10	SI	2	1	2

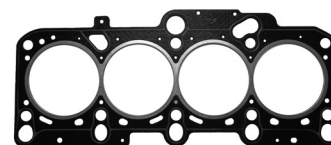

JL46004

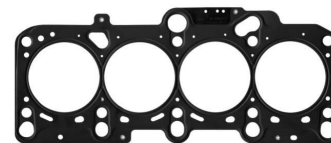

JL46004MLS

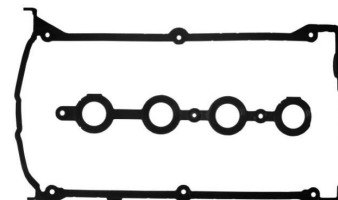

JL46027



JL46132



JL46134



JL46131MLS



JL46516AL



JL11820F



JL46248MLS



JL46234



JL46739



JL46238



JL46239

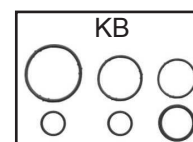

KB

Itens Relacionados

Juntas para  
Cárter

Junta para coletor de  
escapamento

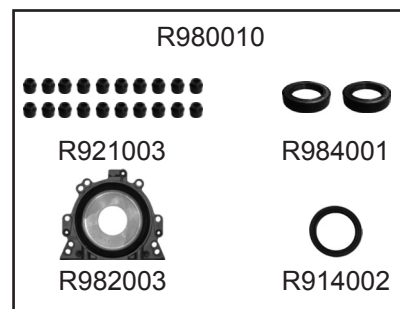
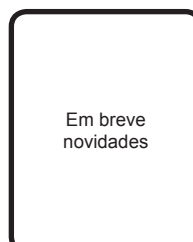
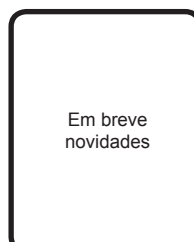
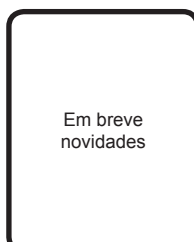
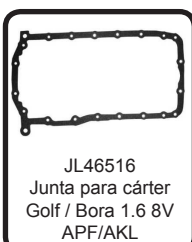



Motor/Engine 1.8 20V ADR/ AEB/ AFY

Códigos jogos de juntas  
Code set gaskets

Modelo / Model	Cm³	De	Até	Completo com retentores <b>46805CR</b>	Full set with oil seals <b>46805CR</b>
Passat	1781	1997		Completo sem retentores <b>46805C</b>	Full set without oil seals <b>46805C</b>
Passat Turbo	1781	1996	1998	Completo MLS com retentores <b>46805CMR</b>	Full set MLS with oil seals <b>46805CMR</b>
A4	1781	1994		Completo MLS sem retentores <b>46805CM</b>	Full set MLS without oil seals <b>46805CM</b>
A4 Turbo	1781	1995		Kit retificação com retentores <b>46805KR</b>	Head set with oil seals <b>46805KR</b>
A6 Turbo	1781	1997		Kit retificação sem retentores <b>46805K</b>	Head set without oil seals <b>46805K</b>
				Kit retificação MLS com retentores <b>46805KMR</b>	MLS Head set with oil seals <b>46805KMR</b>
				Kit retificação MLS sem retentores <b>46805KM</b>	MLS Head set without oil seals <b>46805KM</b>

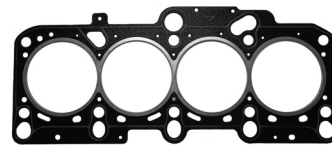

JL46004



JL46004MLS

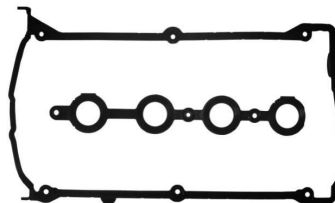

JL46027



JL46132



JL46131MLS

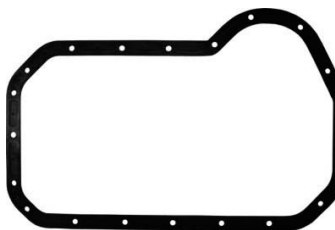

JL46716B



JL11820F



JL46248MLS



JL46739



JL46234



JL46238



JL46239

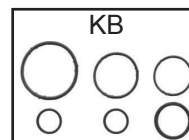

KB

Código/Code	N° Original	Aplicação / application	MP	C	K	M
46004		Cabeçote / cylinder head gasket	PAK	1		
46004MLS		Cabeçote / cylinder head gasket	MLS		1	1
46027	06A103609C	Tampa de válvulas / rocker cover gasket	CHBO	1	1	1
46132		Coletor de admissão / intake manifold	PAK	1	1	1
46131MLS		Coletor de escapamento / exhaust manifold	MLS	1	1	1
46716AL	055.103.609-A	Cárter / oil pan	BOAL	1		1
11820F		Saída do escapamento / exhaust pipe	CNAC	1	1	1
46248MLS		Defletor de óleo	MLS	1		1
46234		Jogo de juntas do tensor da corrente	KA	1		1
46739	056.115.441	Superior do Filtro de óleo / oil filter	NA	1	1	1
46238	035121171/C	Distribuição	NA	1		1
46239		Distribuição	NA	1		1
KB		Kit de borrachas / kit rubbers	KB	1	1	1
R980001		Kit de retentores para motor completo				
R911002	7581344	Retentores de haste de válvulas	VI	20	20	20
R953002	056103051B/D	Retentor traseiro do virabrequim 85x105x12	SI	1		1
R984001	028103085/068103085	Retentor dianteiro / comando de válvulas 32x47x10	SI	3	2	3

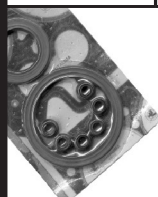

**Juntalima**  
Indústria e Comércio de Auto Peças Ltda

**CONHEÇA NOSSA LINHA  
DE RETENTORES**

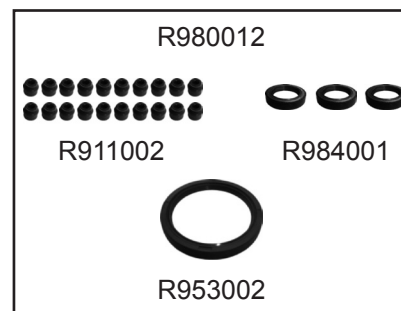



Motor/Engine	1.8 16V TSI CDA/ CDAB
	1.8 16V TSI BZB
	1.8 16V TFSI CCUA/ CDHB
	2.0 16V CBFA/ CFPA/ CCZA
	2.0 16V CCTA/ CCZD
	2.0 16V TFSI CAWB/ CCZA

Códigos jogos de juntas  
Code set gaskets

Completo com retentores <b>46104CR</b>	Full set with oil seals <b>46104CR</b>
Completo sem retentores <b>46104C</b>	Full set without oil seals <b>46104C</b>
Completo MLS com retentores <b>46104CMR</b>	Full set MLS with oil seals <b>46104CMR</b>
Completo MLS sem retentores <b>46104CM</b>	Full set MLS without oil seals <b>46104CM</b>
Kit retificação com retentores <b>46104KR</b>	Head set with oil seals <b>46104KR</b>
Kit retificação sem retentores <b>46104K</b>	Head set without oil seals <b>46104K</b>
Kit retificação MLS com retentores <b>46104KMR</b>	MLS Head set with oil seals <b>46104KMR</b>
Kit retificação MLS sem retentores <b>46104KM</b>	MLS Head set without oil seals <b>46104KM</b>

Modelo / Model	Cm³	De	Até
Passat TSI	1798	2007	
A4	1798	2011	
A4 TFSI	1798	2009	
A5 TFSI	1798	2009	
Jetta	1984	2010	
New Beetle	1984	2011	
Tiguan 4Motion	1984	2011	
Jetta FSI	1984	2005	
Golf FSI	1984	2008	
A3 TFSI	1984	2007	
TT TFSI	1984	2008	
A3 TFSI	1984	2008	

Código/Code	N° Original	Aplicação / application	MP	C	K	M
46104	06h103383ad	Cabeçote / cylinder head gasket	PAK	1	1	
46104MLS	06h103383ad	Cabeçote / cylinder head gasket	MLS			1
46227	06h103483c	Tampa lateral cabeçote / timing cover gasket	BO	1	1	1
46021	06f129717d	Coletor de admissão / intake manifold	BO	1	1	1
46924	06f253039f	Coletor de escapamento / exhaust manifold	CNAC			
46890	1K0253115AB	Saída do escapamento catalizador/ exhaust pipe	CNAC	1	1	1
46891	06F133073D	Corpo da borboleta	BO	1	1	1
46892	06F145757L	Tubo de óleo	CNAC	1		1
46893	06H103121J	Bomba de vácuo	NA	1		1
46894	06J121119	Bomba d'água	BO	1		1
46895	06J115441A	Bomba de óleo	BO	1		1
46896	06J117070C	Resfriador de óleo	BO	1		1
46897		Guarnição	CNAC	1		1
46990		Guarnição	BO	1	1	1
JLKB046		Kit de borrachas / Kit rubbers 13 peças	KB	1	1	1
R980018		Kit de retentores para motor completo	KT			
R911002		Retentores de haste de válvulas	BO	16	16	16
R984005		Retentor dianteiro	BO	1		

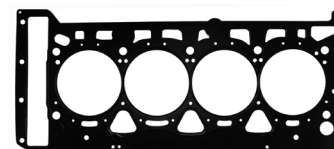

JL46104

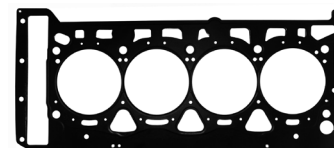

JL46104MLS

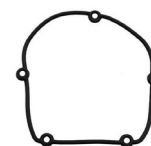

JL46227



JL46021



JL46924

JL46890

JL46891

JL46892

JL46893

JL46894

JL46895

JL46896

JL46897

JL46990

JLKB046

R980018

R911002

R984005

Itens Relacionados

Membrana diafragma

JL46327

Diafrag TV Passat TSI 1.8 16V CCDA BZB/ Jetta FSI 2.0 16V CCTA CBFA

Em breve novidades

Em breve novidades

Em breve novidades

Em breve novidades

133



Motor/Engine 2.0 16V CDBA/ CDCA

Códigos jogos de juntas  
Code set gaskets

Modelo / Model	Cm³	De	Até	Completo sem cabeçote <b>46103SC</b>	Full set without cyl. head gasket <b>46103SC</b>
Amarok TDI	1968	2010		Completo s/cabeçote c/retentores <b>46103SCR</b> Kit retificação sem cabeçote <b>46103KSC</b> Kit s/cabeçote c/retentores <b>46103KSCR</b>	Full set w/o cyl. head gasket with seals <b>46103SCR</b> Retification kit without head gasket <b>46103KSC</b> Head set w/o head gasket with seals <b>46103KSCR</b>

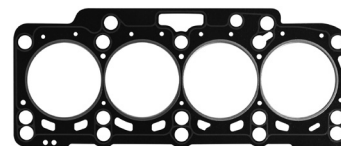

JL46103-1/ JL46103-2/ JL46103-3

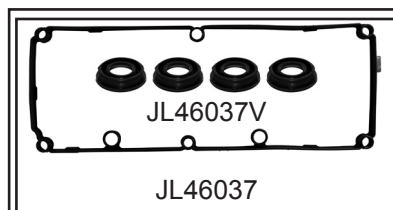

JL46037V

JL46037

JL46037K

OOOOOO



JL46037P

JL46038



JL46039



JL46019

JL46037KC

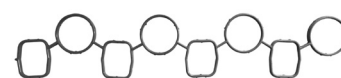

JL46624



JL46324



JL46424



JL46018



JL46325



JL46017



JL46025



JL46015



JL46014



JL46020



JL46016

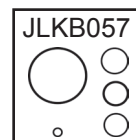

JLKB057

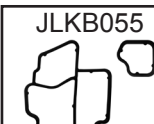

JLKB055

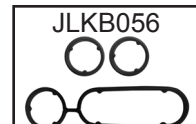

JLKB056



R911002



R984001



R914002

Código/Code	N° Original	Aplicação / application	MP	C	K	M
46103-1	03L103383A	Cabeçote / cylinder head gasket - 1,55mm	PAK			
46103-2		Cabeçote / cylinder head gasket - 1,63mm	PAK			
46103-3		Cabeçote / cylinder head gasket - 1,71mm	PAK			
46037		Tampa de válvulas / rocker cover gasket	BO	1	1	
46037V	03L103070	Kit anéis de vedação injetores	BO	1	1	
46037K		Kit tampa de válvulas e vedadores de velas	KT			
46037P		Kit arruelas / washers set	KA	1	1	
46038		Borracha cabo guia	BO	2	2	
46039		Borracha guia bico de vela	BO	2	2	
46019		Anel bomba d'água	BO	1	1	
46037KC		Kit tampa de válvulas completo	KT			
46624	03L1297170	Coletor de admissão / intake manifold	BO	1	1	
46324	03L253039E	Coletor de escapamento / exhaust manifold	CNAC	1	1	
46424	03L253039G	Coletor de escapamento / exhaust manifold	CNAC	1	1	
46018	06B121119B	Conexão da água para o bloco	BO	1		
46325	038121119	Anel da bomba d'água	BO	1		
46017	038121688B	Conexão da água	BO	1		
46025		Saída do escapamento / exhaust pipe	CU	1		
46015	03L145215A	Selagem da bomba de vácuo	MLS	1		
46014		Guarnição	MLS	1		
46020		Corpo da borboleta	BO	1	1	
46016		Guarnição	BO	1		
JLKB057		Kit borracha / kit rubbers	BO	1		
JLKB055		Kit borracha carcaça do filtro de óleo	BO	1		
JLKB056	03L198070	Kit borracha do radiador e óleo	BO	1		
R980016		Kit de retentores para motor completo				
R911002	036109675	Retentores de haste de válvulas	VI	16	16	
R984001	028103085	Retentor dianteiro / comando de válvulas 32x47x10	SI	1	1	
R914002		Retentor dianteiro do virabrequim 35x48x7	SI	1		

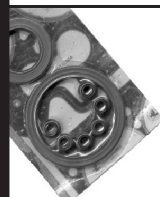

**Juntalima**  
Indústria e Comércio de Auto Peças Ltda

**CONHEÇA NOSSA LINHA  
DE RETENTORES**







Motor/Engine 2.0 8V AP

Códigos jogos de juntas  
Code set gaskets

Modelo / Model	Cm³	De	Até	Completo com retentores <b>46007CR</b>	Full set with oil seals <b>46007CR</b>
Gol	1984	1989	1999	Completo sem retentores <b>46007C</b>	Full set without oil seals <b>46007C</b>
Santana	1984	1989	1999	Completo MLS com retentores <b>46006CMR</b>	Full set MLS with oil seals <b>46006CMR</b>
Quantum	1984	1989	1999	Completo MLS sem retentores <b>46006CM</b>	Full set MLS without oil seals <b>46006CM</b>
Pointer	1984	1989	1999	Kit retificação com retentores <b>46007KR</b>	Head set with oil seals <b>46007KR</b>
Versailles	1984	1992	1996	Kit retificação sem retentores <b>46007K</b>	Head set without oil seals <b>46007K</b>
Verona	1984	1993	1996	Kit retificação MLS com retentores <b>46006KMR</b>	MLS Head set with oil seals <b>46006KMR</b>
Escort	1984	1993	1995	Kit retificação MLS sem retentores <b>46006KM</b>	MLS Head set without oil seals <b>46006KM</b>
Royale	1984	1992	1996	Completo premium com retentores <b>46006CPR</b>	Premium full set with oil seals <b>46006CPR</b>
				Completo premium sem retentores <b>46006CP</b>	Premium full set without oil seals <b>46006CP</b>

Código/Code	Nº Original	Aplicação / application	MP	C	K	M	P
46002AG	053.103.383.4	Cabeçote / cylinder head gasket	PAK	1	1		
46003MLS	026.103.383	Cabeçote / cylinder head gasket	MLS			1	1
46926	056.103.483-C	Tampa de válvulas / rocker cover gasket	CB	1	1	1	1
46022	026.129.717	Coletor de escapamento / exhaust manifold	PAK	1	1	1	1
46716	056.103.609-A	Cárter / oil pan	PAK	1	1		
46716B	056.103.609-A	Cárter Padrão Original / Oil Pan Original Quality	CHBO				1
46024F	843.253.115	Saída do escapamento / exhaust pipe	CNAC	1	1	1	1
46721F	056.129.589	Coletor de Escapamento	CNAC	4	4	4	4
46729	056.103.181	Tampa da distribuição traseira	NA	1	1	1	1
46730	056.103.161	Tampa da distribuição dianteira	NA	1	1	1	1
46731	056.121.139-A	Distribuidor d'água	NA	1	1	1	1
46735	056.115.441	Superior do Filtro de óleo / oil filter	NA	1	1	1	1
46732	056.121.149	Flange do cabeçote	NA	1	1	1	1
46759	056.129.799	Flange do Cabeçote	NA	1	1	1	1
46799		Filtro da bomba de óleo	PP	1	1	1	1
46733PP	026.121.041M	Bomba d'água / water pump	PP	2	2	2	2
016489	056.905.261	Base do distribuidor	NA	1	1	1	1
46768		Anel do cebolão do radiador	NA	1	1	1	1
46247	F70Z6675/AA	Arruela do bujão 14x20	AL	1	1	1	1
25011		Arruela do Bujão 10x14x1,5	AL	1	1	1	1
464747B		Kit de borrachas / kit rubbers	KB	1	1	1	1
R980001		Kit de retentores para motor completo					
R921003	7581344	Retentores de haste de válvulas	VI	8	8	8	8
R953002	056103051B/D	Retentor traseiro do virabrequim 85x105x12	SI	1	1	1	1
R984001	028103085	Retentor dianteiro / comando de válvulas 32x47x10	SI	3	2	3	3



JL46002AG

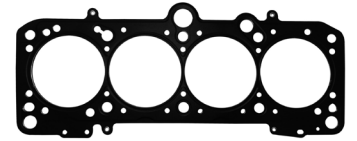

JL46003MLS



JL46926



JL46022

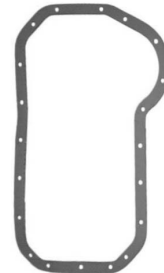

JL46716

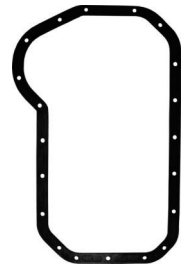

JL46716B



JL46024F



JL46721F  
(x4)



JL46734



JL46729



JL46730



JL46731



JL46735



JL46732



JL46759



JL46799



JL46733PP  
(x2)



JL016489



JL46768



JL46247

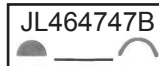

JL464747B



JL25011

Itens Relacionados

Juntas para Carburador

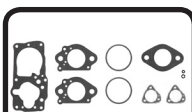

JL46050  
Jg juntas carburador  
Vw Santana 1.8  
Brosol 2-E

Juntas para Carburador

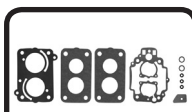

JL46770  
Jg juntas carburador  
Vw Voyage/Saveiro  
TLDZ

Kit de reparo para carburador



JL46750KG  
Kit carburador solex  
112.093 simples  
Passat/Voyage  
gasolina

Kit de reparo para carburador



JL46750KA  
Kit carburador solex  
114.076 simples  
Passat/Voyage  
álcool

Jogo de juntas para câmbio

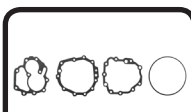

JL46780A  
Jogo junta do câmbio  
Passat/Gol/Santana  
c/ anel 5 marchas

R980001



R921003



R984001



R953002





Motor/Engine 2.0 8V ABA / AKR / ATU  
AWF / AWG (Importado)

Códigos jogos de juntas  
Code set gaskets

Modelo / Model	Cm³	De	Até
Golf	1984	1994	1998
Jetta	1984	1994	1998
Passat	1984	1996	1997
Vento	1984	1997	1998
Golf Cabriolet	1984	1999	2002

Completo com retentores  
**46201CR**  
Completo sem retentores  
**46201C**  
Kit retificação com retentores  
**46201KR**  
Kit retificação sem retentores  
**46201K**

Full set with oil seals  
**46201CR**  
Full set without oil seals  
**46201C**  
Head set with oil seals  
**46201KR**  
Head set without oil seals  
**46201K**

Código/Code	N° Original	Aplicação / application	MP	C	K	M
46903G	037.103.383N	Cabeçote / cylinder head gasket	PAK	1	1	
46226	026.103.483.2	Tampa das válvulas / rocker cover	CHBO	1	1	
46521	037.253.039D	Coletor de escapamento / exhaust manifold	CNAC	1	1	
46822	191.298.004.01	Coletor de admissão / intake manifold	PAK	1	1	
46922	191.298.004.02	Coletor de admissão / intake manifold	PAK	1	1	
46716	056.103.690A	Cárter / oil pan	PAK	1		
11820F		Saída do escapamento / exhaust pipe	CNAC	1	1	
46733AL	026.121.041M	Bomba d'água / water pump	BOAL	1	1	
46432	056.103.181	Tampa distribuição traseira	NA	1		
46730	056.103.161	Tampa distribuição dianteira	NA	1		
46739	056.115.441	Filtro superior do óleo	NA	1		
46732	056.121.149	Flange do cabeçote	NA	1	1	
46799		Filtro da bomba de óleo	PP	1		
VW0003	056.905.261	Base do distribuidor	NA	2		
25011		Arruela 14x20x1,5	AL	1		
25018		Arruela 10x14x1	AL	1		
R980014		Kit de retentores para motor completo				
R921001		Retentores de haste de válvulas	VI	8	8	
R953002	056103051B/C	Retentor traseiro do virabreum 85x105x12	SI	1		
R984001	028103085/068103085	Retentor dianteiro / comando de válvulas 32x47x10	SI	3	2	

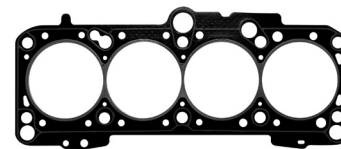

JL46903G



JL46226



JL46521



JL46822



JL46922

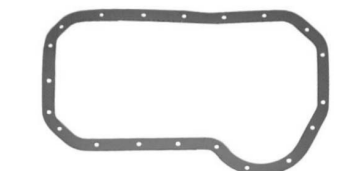

JL46716



JL11820F



JL46733AL



JL46432



JL46730



JL46739



JL46732



JL46799



JL016489(x2)



JL25011



JL25018

Itens Relacionados

Juntas para Injeção Eletrônica

Juntas para Injeção Eletrônica

Juntas para Injeção Eletrônica

Retentores

Juntas para Cárter

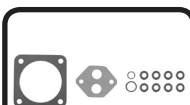

JL15904  
Jg de juntas para I.E. Golf 1.8/2.0 multipoint Importado c/ 8 aneis viton



JL15905  
Jg de juntas para I.E. Golf 1.8 Pointer Singlepoint (anel viton)



JL15907  
Jg de juntas para I.E. Polo Classic 1.8 Multipoint (anel viton)



R982003  
Ret traseiro do vira com flange Passat/Santana/Golf 8mm 06A103171A



JL46716B  
Cárter Santana/Golf/Audi borracha c/ alma de aço

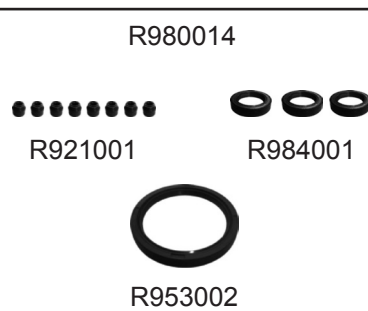



Motor/Engine 2.0 8V ADY / AEP / AGG

Códigos jogos de juntas  
Code set gaskets

Modelo / Model	Cm³	De	Até	Completo MLS com retentores <b>46808CMR</b>	Full set MLS with oil seals <b>46808CMR</b>
Golf	1984	1994	1997	Completo MLS sem retentores <b>46808CM</b>	Full set MLS without oil seals <b>46808CM</b>
Corrado	1984	1994	1995	Kit retificação MLS com retentores <b>46808KMR</b>	MLS Head set with oil seals <b>46808KMR</b>
Passat	1984	1994	1996	Kit retificação MLS sem retentores <b>46808KM</b>	MLS Head set without oil seals <b>46808KM</b>
Vento	1984	1994	1997		
Sharan	1984	1995			

Código/Code	Nº Original	Aplicação / application	MP	C	K	M
46003MLS		Cabeçote / cylinder head gasket	MLS		1	1
46226	026.103.483.2	Tampa de válvulas / rocker cover gasket	CHBO		1	1
46521	037.253.039D	Coletor de escapamento / exhaust manifold	CNAC		1	1
46822	191.298.004.01	Coletor de admissão / intake manifold	PAK		1	1
46123	026129717F	Coletor de admissão / intake manifold	PAK		1	1
46022	026.129.171	Coletor de admissão / intake manifold	PAK		1	1
46721F	056.129.589	Coletor de escapamento	CNAC		4	4
46716	056.103.690A	Cárter / oil pan	PAK			1
11820F		Saída do escapamento / exhaust pipe	CNAC		1	1
46733AL	026.121.041M	Bomba d'água / water pump	BOAL		1	1
46432	056.103.181	Tampa da distribuição traseira	NA			1
46730	056.103.161	Tampa da distribuição dianteira	NA			1
46739	056.115.441	Filtro superior do óleo	NA			1
46732	056.121.149	Flange do cabeçote	NA		1	1
46799		Filtro da bomba de óleo	PP			1
016489	056.905.261	Base do distribuidor	NA			2
25011		Arruela 10x14x1,5	AL			1
25018		Arruela 14x20x1,5	AL			1
R980014		Kit de retentores para motor completo				
R921001		Retentores de haste de válvulas	VI		8	8
R953002	056103051B/D	Retentor traseiro do virabrequim 85x105x12	SI			1
R984001	028103085/068103085	Retentor dianteiro / comando de válvulas 32x47x10	SI		2	3

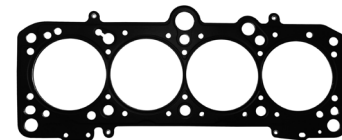

JL46003MLS



JL46226



JL46521



JL46822



JL46123



JL46022

JL46721F(x4)

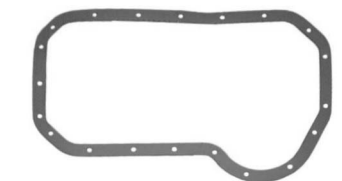

JL46716



JL11820F

JL46733AL



JL46432

JL46730



JL46739

JL46799

JL25011



JL46732

JL016489(x2)

JL25018

**R980014**

R921001

R984001

R953002

**Itens Relacionados**

Juntas para Injeção Eletrônica	Juntas para Injeção Eletrônica	Juntas para Injeção Eletrônica	Retentores	Juntas para Cárter
 <b>JL15904</b> Jg de juntas para I.E. Golf 1.8/2.0 multipoint Importado c/ 8 anéis viton	 <b>JL15905</b> Jg de juntas para I.E. Golf 1.8 Pointer Singlepoint (anel viton)	 <b>JL15907</b> Jg de juntas para I.E. Polo Classic 1.8 Multipoint (anel viton)	 <b>R982003</b> Ret traseiro do vira com flange Passat/Santana/Golf 8mm 06A103171A	 <b>JL46716B</b> Cárter Santana/Golf/Audi borracha c/ alma de aço



Motor/Engine 2.0 8V APK/AQY/AZH/ATM

Códigos jogos de juntas  
Code set gaskets

Modelo / Model	Cm <sup>3</sup>	De	Até	Completo com retentores <b>46906CR</b>	Full set with oil seals <b>46906CR</b>
Golf	1984	1998		Completo sem retentores <b>46906C</b>	Full set without oil seals <b>46906C</b>
Bora	1984	1998		Completo MLS com retentores <b>46906CMR</b>	Full set MLS with oil seals <b>46906CMR</b>
New Beetle	1984	1998		Completo MLS sem retentores <b>46906CM</b>	Full set MLS without oil seals <b>46906CM</b>
Jetta	1984	1998	2002	Kit retificação com retentores <b>46906KR</b>	Head set with oil seals <b>46906KR</b>
Sharan	1984	2000	2001	Kit retificação sem retentores <b>46906K</b>	Head set without oil seals <b>46906K</b>
				Kit retificação MLS com retentores <b>46906KMR</b>	MLS Head set with oil seals <b>46906KMR</b>
				Kit retificação MLS sem retentores <b>46906KM</b>	MLS Head set without oil seals <b>46906KM</b>

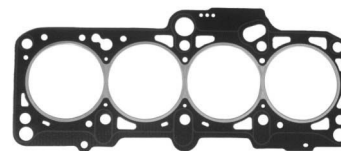

JL46906G

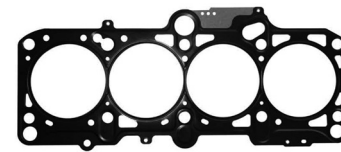

JL46906MLS



JL46226



JL46423



JL46822



JL46823



JL46516AL



JL11820F



JL46820



JL46234



JL46248



JL46739



JL46238



JL46239

Código/Code	N° Original	Aplicação / application	MP	C	K	M	P
46906G	06B/103383/H	Cabeçote / cylinder head gasket	PAK	1	1		1
46906MLS	06B/103383/H	Cabeçote / cylinder head gasket	MLS			1	1
46226	026.103.483/2	Tampa de válvulas / rocker cover gasket	CHBO	1	1	1	1
46423		Coletor de escapamento / exhaust manifold	CNAC	1	1	1	1
46822	191.298.004.01	Coletor de admissão / intake manifold	PAK	1	1	1	1
46823		Coletor de admissão / intake manifold	PAK	1	1	1	1
46516AL		Cárter / oil pan	BOAL	1		1	1
46820		Saída do escapamento / exhaust pipe	CNAC	1	1	1	1
11820F		Saída do escapamento / exhaust pipe	CNAC	1	1	1	1
46248		Defletor de óleo	MLS	1		1	1
46234		jogo de juntas do tensor da corrente	KA	1		1	1
46739	056.115.441	Superior do Filtro de óleo / oil filter	NA	1	1	1	1
46238	035121171/C	Distribuição	NA	1		1	1
46239		Distribuição	NA	1		1	1
R980011		Kit de retentores para motor completo					
R921001	7581344	Rtentores de haste de válvulas	VI	8	8	8	8
R984001	028103085	Retentor do comando de válvulas 32x47x10	SI	1	1	1	1
R982003		Retentor traseiro do virabrequim flange	PTFE	1		1	1
R914002		Retentor dianteiro do virabrequim 35x48x7	SI	1		1	1

Itens Relacionados

Juntas para  
Cárter

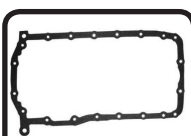

JL46516  
Junta para cárter  
Golf / Bora 1.6 8V  
APF/AKL

Em breve  
novidades

Em breve  
novidades

Em breve  
novidades

Em breve  
novidades

R980011

R921001

R984001

R982003

R914002



Motor/Engine 2.0 8V BBX  
2.0 8V BEH

Códigos jogos de juntas  
Code set gaskets

Modelo / Model Cm³ De Até

Golf	1984	2002	2006
Polo	1985	2002	
New Beetle	1985	2002	

Completo com retentores <b>46601CR</b>	Full set with oil seals <b>46601CR</b>
Completo sem retentores <b>46601C</b>	Full set without oil seals <b>46601C</b>
Completo MLS com retentores <b>46601CMR</b>	Full set MLS with oil seals <b>46601CMR</b>
Completo MLS sem retentores <b>46601CM</b>	Full set MLS without oil seals <b>46601CM</b>
Kit retificação com retentores <b>46601KR</b>	Head set with oil seals <b>46601KR</b>
Kit retificação sem retentores <b>46601K</b>	Head set without oil seals <b>46601K</b>
Kit retificação MLS com retentores <b>46601KMR</b>	MLS Head set with oil seals <b>46601KMR</b>
Kit retificação MLS sem retentores <b>46601KM</b>	MLS Head set without oil seals <b>46601KM</b>

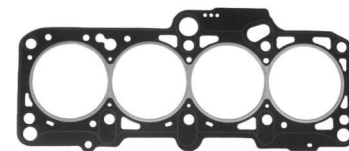

JL46906G

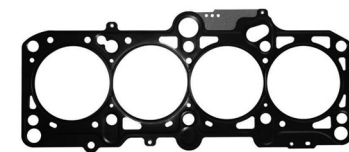

JL46906MLS

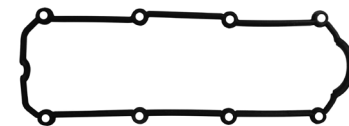

JL46136



JL46423



JL46221



JL46323



JL46516AL



JL46820



JL11820F



JL46248



JL46234



JL46739



JL46238



JL46239

Código/Code	N° Original	Aplicação / application	MP	C	K	M	P
46906G	06B/103383/H	Cabeçote / cylinder head gasket	PAK	1	1		1
46906MLS	06B/103383/H	Cabeçote / cylinder head gasket	MLS			1	1
46136		Tampa de válvulas / rocker cover gasket	BO	1	1	1	1
46423		Coletor de escapamento / exhaust manifold	CNAC	1	1	1	1
46323		Coletor de admissão / intake manifold	BO	4	4	4	4
46221		Coletor de admissão / intake manifold	BO	4	4	4	4
46516AL		Cárter / oil pan	BOAL				1
46820		Saída do escapamento / exhaust pipe	CNAC	1	1	1	1
11820F		Saída do escapamento / exhaust pipe	CNAC	1	1	1	1
46248		Defletor de óleo	MLS	1		1	1
46234		jogo de juntas do tensor da corrente	KA	1		1	1
46739	056.115.441	Superior do Filtro de óleo / oil filter	NA	1	1	1	1
46238	035121171/C	Distribuição	NA	1		1	1
46239		Distribuição	NA	1		1	1
R980011		Kit de retentores para motor completo					
R921001	7581344	Retentores de haste de válvulas	VI	8	8	8	8
R984001	028103085	Retentor do comando de válvulas 32x47x10	SI	1	1	1	1
R982003		Retentor traseiro do virabrequim flange	PTFE	1		1	1
R914002		Retentor dianteiro do virabrequim 35x48x7	SI	1		1	1

Itens Relacionados

Juntas para  
Cárter

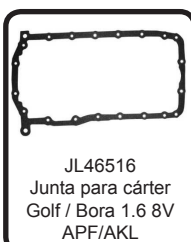

Em breve  
novidades

Em breve  
novidades

Em breve  
novidades

Em breve  
novidades

R980011

R921001

R984001

R982003

R914002





Motor/Engine 2.0 8V AP (Injeção eletrônica)

Códigos jogos de juntas  
Code set gaskets

Modelo / Model	Cm³	De	Até	Completo com retentores <b>46009CR</b>	Full set with oil seals <b>46009CR</b>
Parati	1985	1985		Completo sem retentores <b>46009C</b>	Full set without oil seals <b>46009C</b>
Santana	1985	1998		Completo MLS com retentores <b>46008CMR</b>	Full set MLS with oil seals <b>46008CMR</b>
Saveiro	1985	1998		Completo MLS sem retentores <b>46008CM</b>	Full set MLS without oil seals <b>46008CM</b>
				Kit retificação com retentores <b>46009KR</b>	Head set with oil seals <b>46009KR</b>
				Kit retificação sem retentores <b>46009K</b>	Head set without oil seals <b>46009K</b>
				Kit retificação MLS com retentores <b>46008KMR</b>	MLS Head set with oil seals <b>46008KMR</b>
				Kit retificação MLS sem retentores <b>46008KM</b>	MLS Head set without oil seals <b>46008KM</b>

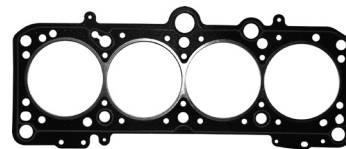

JL46002AG

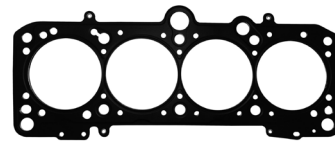

JL46003MLS



JL46226



JL46728

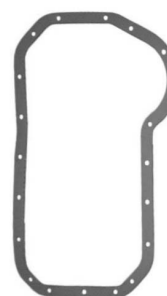

JL46716

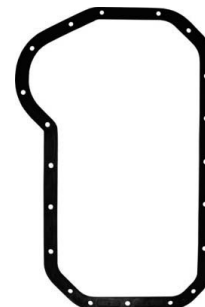

JL46716B

Código/Code	Nº Original	Aplicação / application	MP	C	K	M	P
46002AG	053.103.383.4	Cabeçote / cylinder head gasket	PAK	1	1		
46003MLS	026.103.383	Cabeçote / cylinder head gasket	MLS			1	1
46226	026/102483/2	Tampa de válvulas / rocker cover gasket	CHBO	1	1	1	1
46728	056.129.717	Coletor de admissão / intake manifold	PAK	1	1	1	1
46716	056.103.609-A	Cárter / oil pan	PAK	1		1	
46716B	056.103.609-A	Cárter Padrão Original / Oil Pan Original Quality	BOAL				1
46024F	843.253.115	Saída do escapamento / exhaust pipe	CNAC	1	1	1	1
46721F	056.129.589	Jogo do Coletor de Escapamento	CNAC	4	4	4	1
46723		Saída do escapamento / exhaust pipe	CNAC	1	1	1	1
46733AL	056.121.041A	Bomba d'água padrão original metal - borracha	BOAL				1
46734	056.121.041A	Bomba d'água / water pump	GV	1		1	
46729	056.103.181	Tampa da distribuição traseira	NA	1		1	1
46730	056.103.161	Tampa da distribuição dianteira	NA	1		1	1
46731	056.121.139-A	Distribuidor d'água	NA	1	1	1	1
46735	056.115.441	Superior do Filtro de óleo / oil filter	NA	1		1	1
46732	056.121.149	Flange do cabeçote	NA	1	1	1	1
46759	056.129.799	Flange do cabeçote	NA	1		1	1
46799		Filtro da bomba de óleo	PP	1		1	1
46733PP	026.121.041M	Bomba d'água / water pump	PP	2		2	2
016489	056.905.261	Base do distribuidor	NA	1		1	1
46768		Anel do cebolão do radiador	NA	1		1	1
46247	F70Z6675/AA	Arruela do bujão 14x20	AL	1		1	1
25011		Arruela 10x14x1,5	AL	1		1	1
464747B		Kit de borrachas / kit rubbers	KB	1	1	1	1
R980014		Kit de retentores para motor completo					
R921001		Retentores de haste de válvulas	VI	8	8	8	8
R953002	056103051B/D	Retentor traseiro do virabrequim 85x105x12	SI	1		1	1
R984001	028103085/068103085	Retentor dianteiro / comando de válvulas 32x47x10	SI	3	2	3	3



JL46024F



JL46721F(x4)



JL46723



JL46730



JL46759



JL46733AL



JL46734



JL46729



JL46731



JL46735



JL46732



JL46799



JL46733PP(x2)



JL016489



JL46768



JL46247

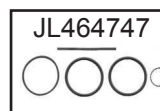

JL464747



JL25011

Itens Relacionados

Juntas para Injeção Eletrônica

Juntas para Câmbio

Retentores



JL15900  
Jg de juntas para I.E.  
Santana 1.8/2.0  
Pointer singlepoint

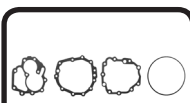

JL46780A  
Jg de juntas câmbio  
Passat/Gol/Santana  
c/anel 5 marchas



R982003  
Retentor traseiro vira  
c/ flange Pst/Sant  
Golf 8mm  
06A103171A



Em breve novidades



Em breve novidades

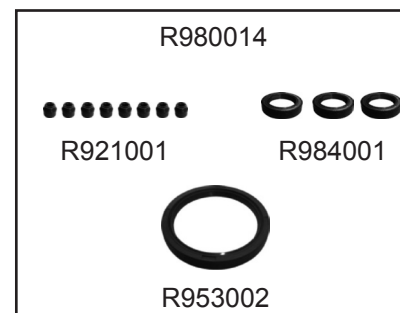

R921001

R984001



R953002



Motor/Engine 2.0 16V ABF

Códigos jogos de juntas  
Code set gaskets

Modelo / Model	Cm³	De	Até	Completo MLS com retentores <b>46102CMR</b>	Full set MLS with oil seals <b>46102CMR</b>
Gol	1985	1995	2000	Completo MLS sem retentores <b>46102CM</b>	Full set MLS without oil seals <b>46102CM</b>
Parati	1985	1996	2000	Kit retificação MLS com retentores <b>46102KMR</b>	MLS Head set with oil seals <b>46102KMR</b>
Golf	1985	1992	1997	Kit retificação MLS sem retentores <b>46102KM</b>	MLS Head set without oil seals <b>46102KM</b>

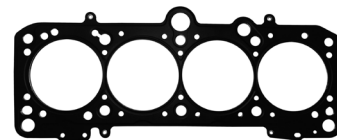

JL46003MLS

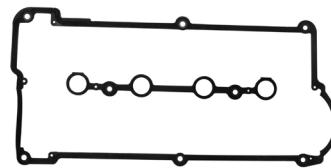

JL46026



JL46122



JL46124(x4)

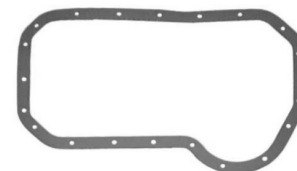

JL46716

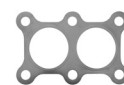

JL11820F



JL46733AL



JL46735



JL46729



JL46759



JL46730



JL46799



JL46733PP



JLKB024

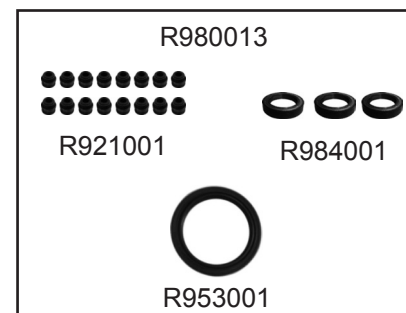

R980013

R921001

R984001

R953001

Código/Code	Nº Original	Aplicação / application	MP	C	K	M
46003MLS	026.103.383	Cabeçote / cylinder head gasket	MLS		1	1
46026		Tampa de válvulas / rocker cover gasket	BOAL		1	1
46122		Coletor de admissão / intake manifold	PAK		1	1
46124		Coletor de escapamento / exhaust manifold	CNAC		4	4
46716	056.103.609A	Cárter / oil pan	PAK		1	1
11820F		Saída do escapamento / exhaust pipe	CNAC		1	1
46733AL	026.121.041M	Bomba d'água / water pump	AL			1
46729	056.103.181	Tampa da distribuição traseira	NA			1
46730	056.103.161	Tampa da distribuição dianteira	NA			1
46735	056.115.441	Superior do Filtro de óleo / oil filter	NA			1
46759	056.129.799	Flange do cabeçote	NA			1
46799		Filtro da bomba de óleo	PP			1
46733PP	026.121.041M	Bomba d'água / water pump	PP			1
JLKB024		Kit de borrachas / kit rubbers	BO	1		1
R980013		Kit de retentores para motor completo				
R921001	7581344	Retentor haste de válvulas	VI		16	16
R953001	011906/012728	Retentor traseiro do virabrequim 90x110x7	SI			1
R984001	028105/068103085	Retentor dianteiro do comando de válvulas 32x47x10	SI		2	3

Itens Relacionados

Juntas para  
Cárter

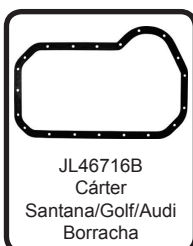

Em breve  
novidades

Em breve  
novidades

Em breve  
novidades

Em breve  
novidades

Volkswagen



Juntalima

Motor/Engine 2.5 20V BGP / BGQ  
2.5 20V BPR / BPS  
2.5 20V BTK / CBTA  
2.5 20V CCCA / CBUA

Códigos jogos de juntas  
Code set gaskets

Completo com retentores  
**46301CR**

Full set with oil seals  
**46301CR**

Completo sem retentores  
**46301C**

Full set without oil seals  
**46301C**

Kit retificação com retentores  
**46301KR**

Head set with oil seals  
**46301KR**

Kit retificação sem retentores  
**46301K**

Head set without oil seals  
**46301K**

Modelo / Model	Cm³	De	Até
Jetta	2480	2005	2007
Bora	2480	2005	2007
Golf	2480	2007	
New Beetle	2480	2005	2009

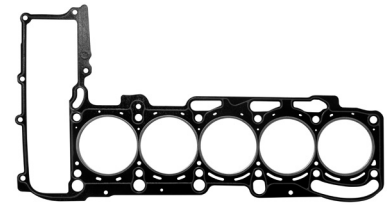

JL46301

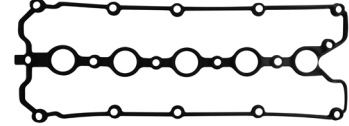

JL46036



JL46523



JL46524



JL46525

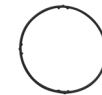

JL46052



JL46053



JL46054



JL46055

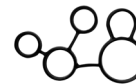

JL46056



JL46057

Código/Code	N° Original	Aplicação / application	MP	C	K	M
46301		Cabeçote / cylinder head gasket	PAK	1	1	
46036	07K103483B	Tampa de válvulas / rocker cover gasket	BO	1	1	
46523		Coletor de admissão / intake manifold	BO	5	5	
46524		Coletor de escapamento / exhaust manifold	CNAC	1	1	
46525		Saída do escapamento / exhaust pipe	CNAC	1		
46052		Guarnição	BO	1		
46053		Guarnição	BO	1		
46054		Guarnição	BO	1		
46055		Guarnição	BO	1		
46056		Guarnição	BO	1		
46057		Guarnição	BO	1		
R980015		Kit de retentores para motor completo				
R921003	7581344	Retentores de haste de válvulas	VI	20	20	
R953002	056103051B/D	Retentor traseiro do virabrequim 85x105x12	SI	1		

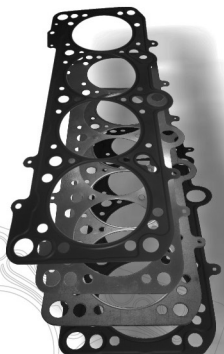

**Juntalima**  
Indústria e Comércio de Auto Peças Ltda







**REFERÊNCIA NACIONAL  
EM JUNTAS MLS**

R980015

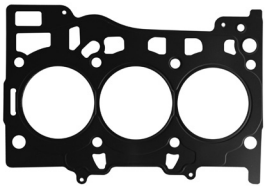
R921003

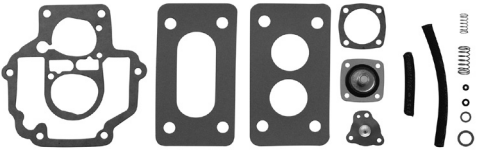



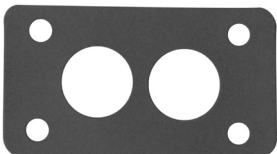



R953002

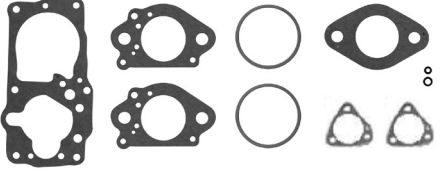

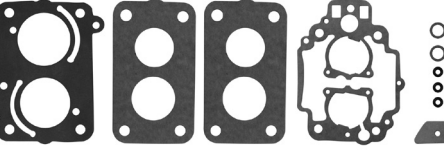

Junta	Aplicação	Veículo / Motor
 JL46105MLS	Junta do cabeçote	Up! 1.0 12V Motor EA211 MPI CHYA/ CHYB - MLS
 JL46904G	Junta do cabeçote	Gol/ Saveiro/ Parati
 JL46827	Junta coletor de admissão	Audi A4/ A6 2.4 V6 motor AFM (Embalagem com 10 peças)
 JL46051	Junta base do carburador	Gol/Corcel II/Pampa AP 1600
 JL46223	Junta base do carburador	-
 JL46450	Jogo de juntas para carburador	1300/1500
 JL46650	Junta base do carburador	Brasilia Dupla
 JL46740	Jogo de juntas para carburador	Passat TS







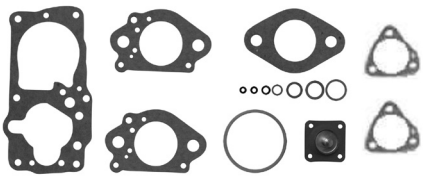
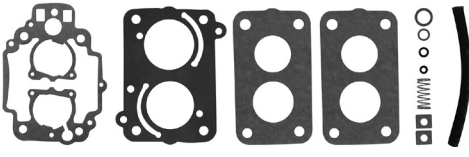
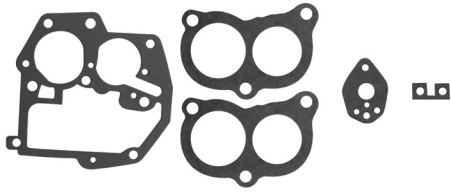
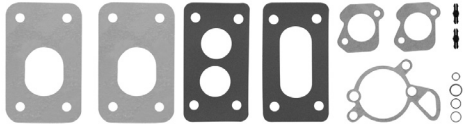
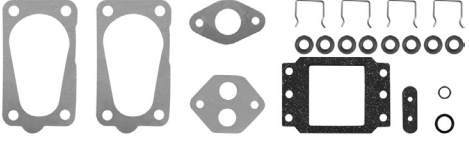

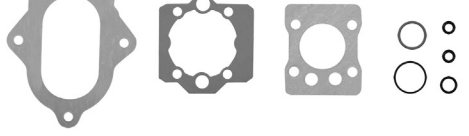
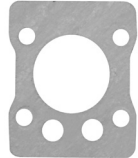
Junta	Aplicação	Veículo / Motor
 <p>JL46750</p>	Jogo de juntas para carburador	Passat LS
 <p>JL46760</p>	Jogo de juntas para carburador	Passat TS 1.6 Solex importado
 <p>JL46770</p>	Jogo de juntas para carburador	Voyage/Saveiro TLDZ
 <p>JL46870</p>	Kit de reparos para carburador	Gol/Voyage/Parati 1.6 Weber
 <p>JL46050KG</p>	Kit de reparos para carburador	Santana 1.8 Brosol 2-E
 <p>JL46450K</p>	Kit de reparos para carburador	VW todos simples álcool/gasolina Solex 112.093
 <p>JL46650K</p>	Kit de reparos para carburador	Brasilia duplo álcool/gasolina Solex 114.093
 <p>JL46750KA</p>	Kit de reparos para carburador	Passat/Voyage simples álcool Solex 114.076



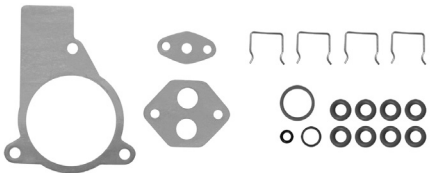

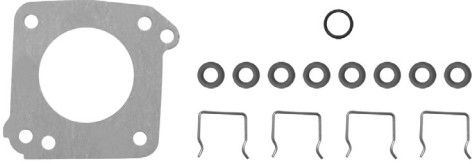
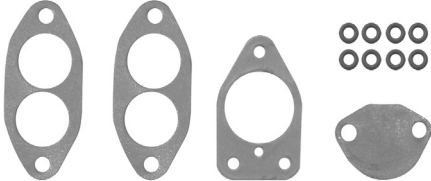
Junta	Aplicação	Veículo / Motor
 <p>JL46750KG</p>	<p>Kit de reparos para carburador</p>	<p>Passat/Voyage simples gasolina Solex 112.093</p>
 <p>JL46770K</p>	<p>Kit de reparos para carburador</p>	<p>Gol/Voyage/Parati gasolina Weber 401.73302 TLDZ</p>
 <p>JL46050</p>	<p>Jogo de juntas para carburador</p>	<p>Santana 1.8 Brosol 2-E</p>
 <p>JL15902</p>	<p>Jogo de juntas para injeção eletrônica</p>	<p>Gol 1000 plus CFI AE (anel viton)</p>
 <p>JL15903</p>	<p>Jogo de juntas para injeção eletrônica</p>	<p>Gol GTI/Logus/Pointer 2.0 (anel viton)</p>
 <p>JL15904</p>	<p>Jogo de juntas para injeção eletrônica</p>	<p>Golf 1.8/2.0 Mltipoint importado (c/ 8 aneis viton)</p>
 <p>JL15905</p>	<p>Junta base da injeção eletrônica</p>	<p>Golf/Pointer 1.8 singlepoint (anel viton)</p>
 <p>JL15905A</p>	<p>Junta base da injeção eletrônica</p>	<p>Gol/Pointer 1.8 (menor)</p>

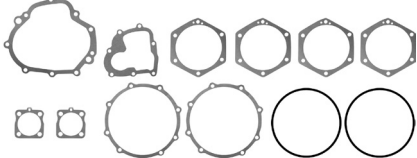

Junta	Aplicação	Veículo / Motor
 <p>JL15905B</p>	Junta para injeção eletrônica	Gol/Pointer 1.8 (maior)
 <p>JL15906</p>	Jogo de juntas para injeção eletrônica	Golf 1.8/Gol 1000 Ap Multipoint (anel viton)
 <p>JL15907</p>	Jogo de juntas para injeção eletrônica	Polo Classic 1.8 multipoint (anel viton)
 <p>JL15908</p>	Jogo de juntas para injeção eletrônica	Gol/Parati 1.0 MI 8V (anel viton)
 <p>JL15909</p>	Jogo de juntas para injeção eletrônica	Gol/Parati 1.0 MI 16V (anel viton)
 <p>JL15910</p>	Jogo de juntas para injeção eletrônica	Kombi 4cc Multipoint
 <p>JL15900</p>	Jogo de juntas para injeção eletrônica	Santana/Pointer 1.8/2.0 Singlepoint
 <p>JL46490</p>	Jogo de juntas para câmbio	1300/1500/1600 com anel

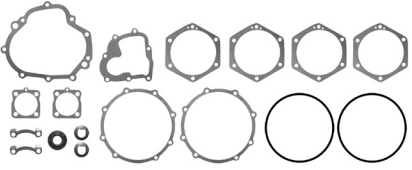
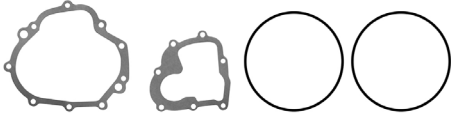

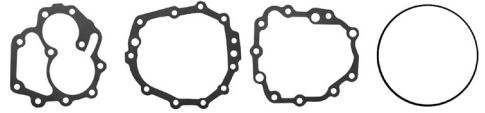
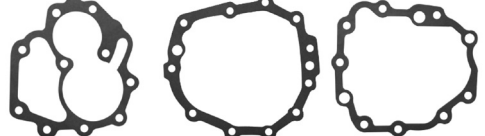
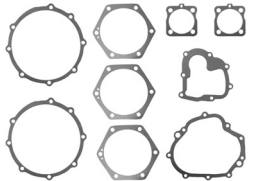
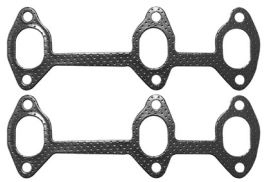
Junta	Aplicação	Veículo / Motor
 <p>JL46490TR</p>	Jogo de juntas para câmbio	1300/1500/1600 com anel, trava e retentor
 <p>JL46491</p>	Jogo de juntas para câmbio	Kombi Cliper 76 com anel
 <p>JL46491C</p>	Jogo de juntas para câmbio	Kombi Cliper sem anel com redução
 <p>JL46780</p>	Jogo de juntas para câmbio	Passat TS/LS 4 marchas
 <p>JL46780A</p>	Jogo de juntas para câmbio	Passat/Gol/Santana com anel 5 marchas
 <p>JL46780B</p>	Jogo de juntas para câmbio	Passat/Gol/Santana sem anel 5 marchas
 <p>JL46480</p>	Jogo de juntas para câmbio	1300/1500/1600 sem anel
 <p>JL46828</p>	Junta do coletor de escapamento	Audi A4/ A6 2.4 V6 motor AFM (Embalagem com 5 peças)





Junta

Aplicação

Veículo / Motor



R982004

Flange traseira do virabrequim

Gol Power  
1.0 8/ 16V 1.6 8V  
PTFE alojamento quadrado

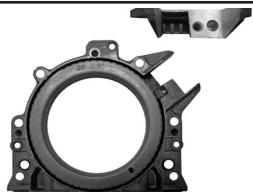

R982005

Retentor da flange traseira

Gol AT 1.0 16V Turbo